

HOW TO PRINT THIS PATTERN

Print out this 24-page PDF on to A4 paper. Trim away the shaded border from each page and position the pages as below to assemble the pattern...

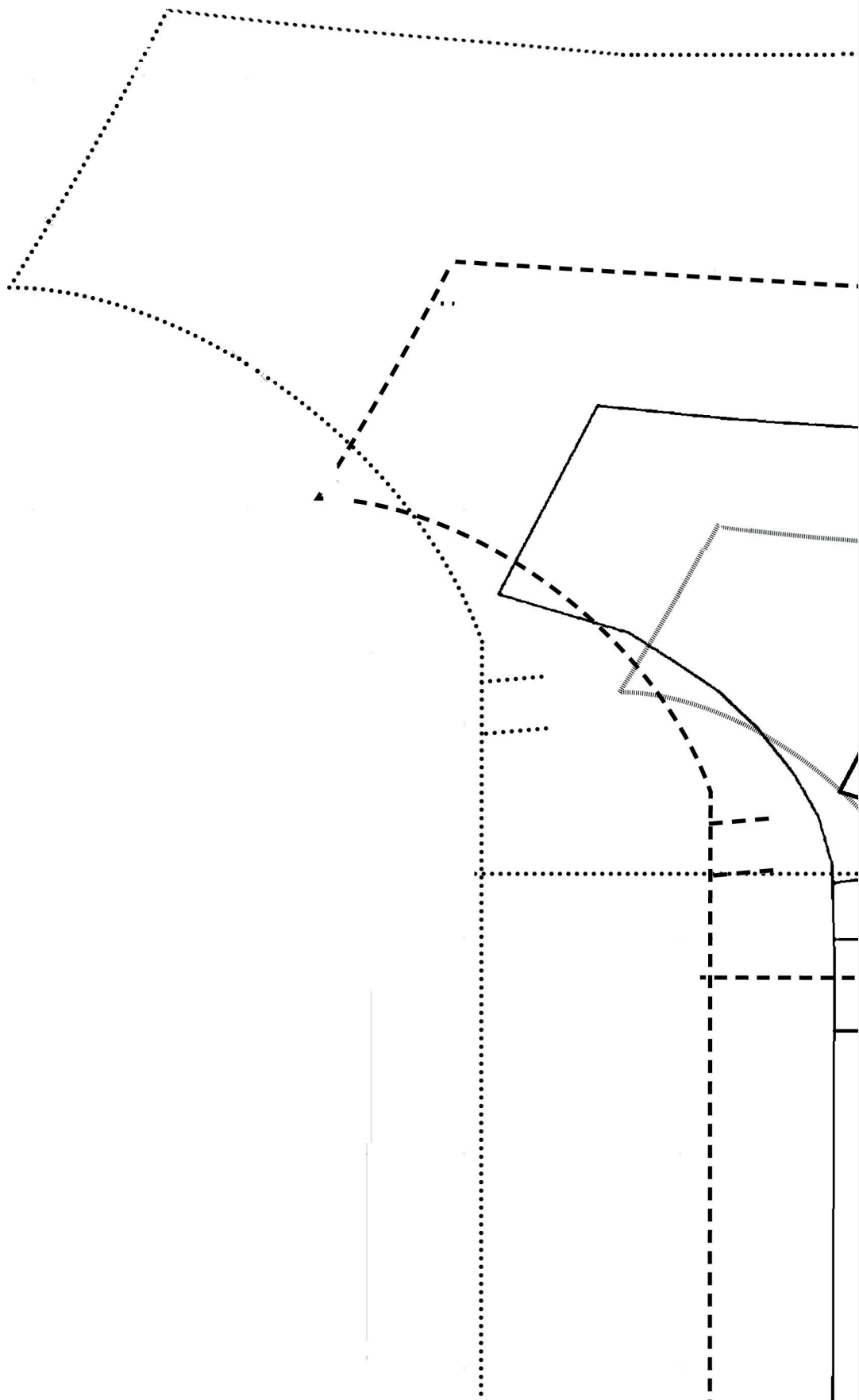

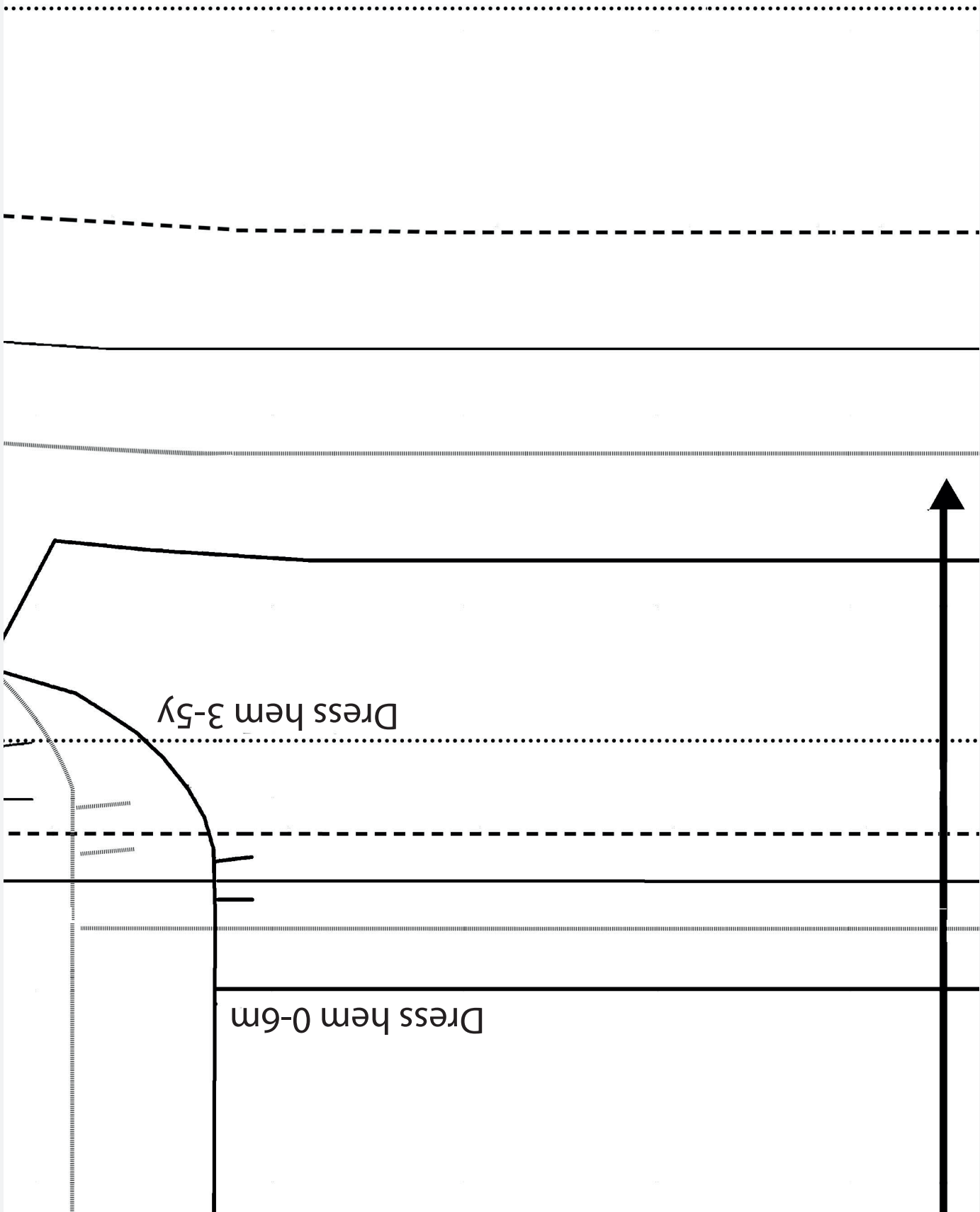

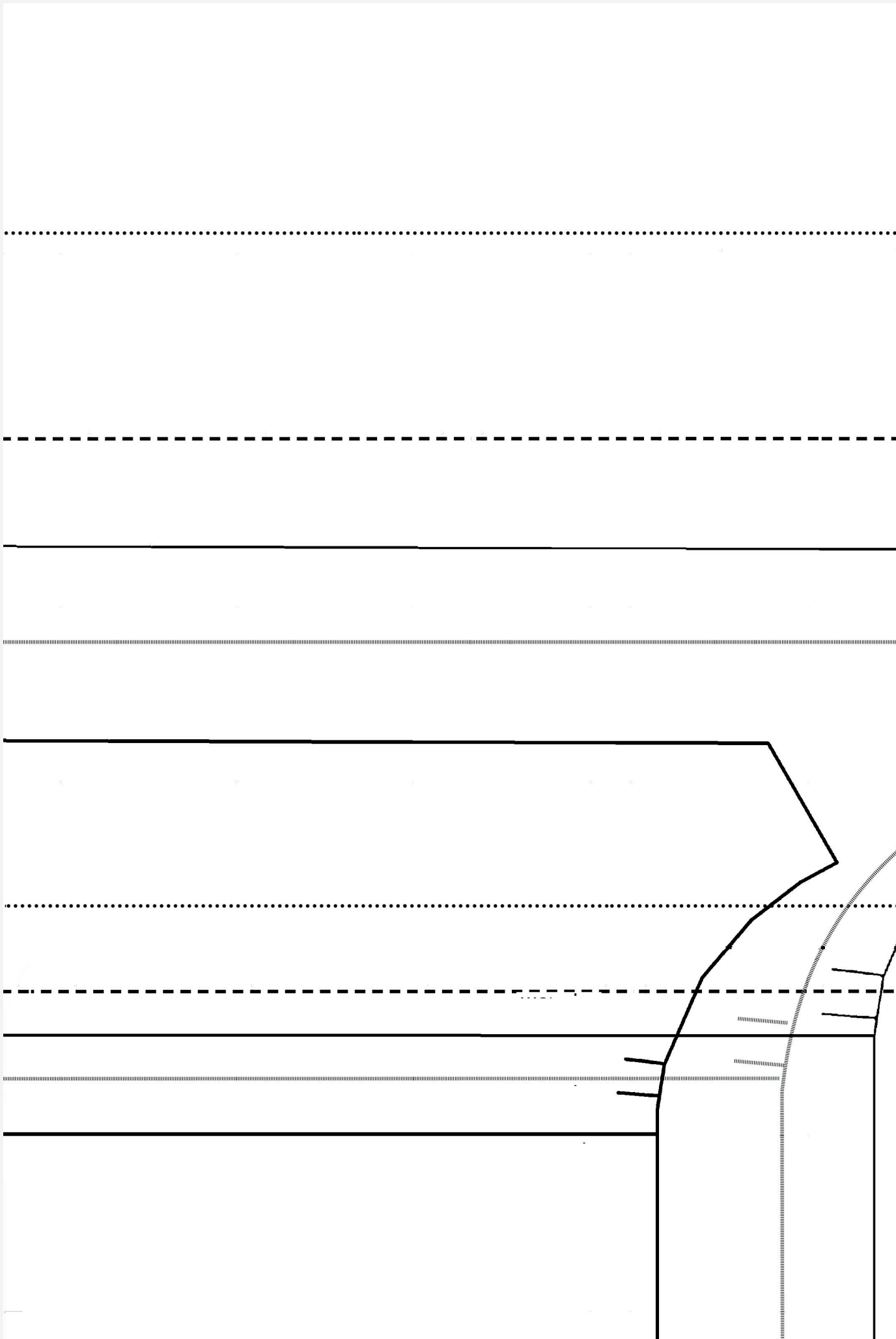

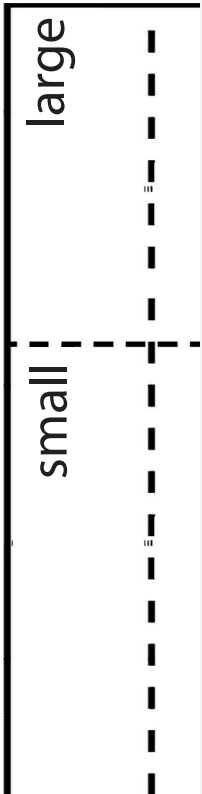
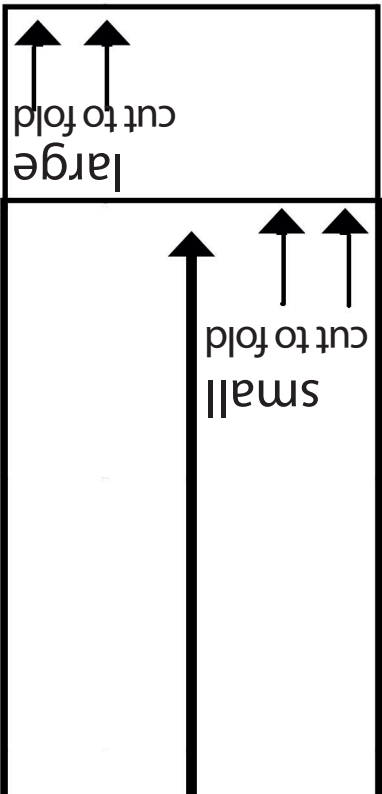
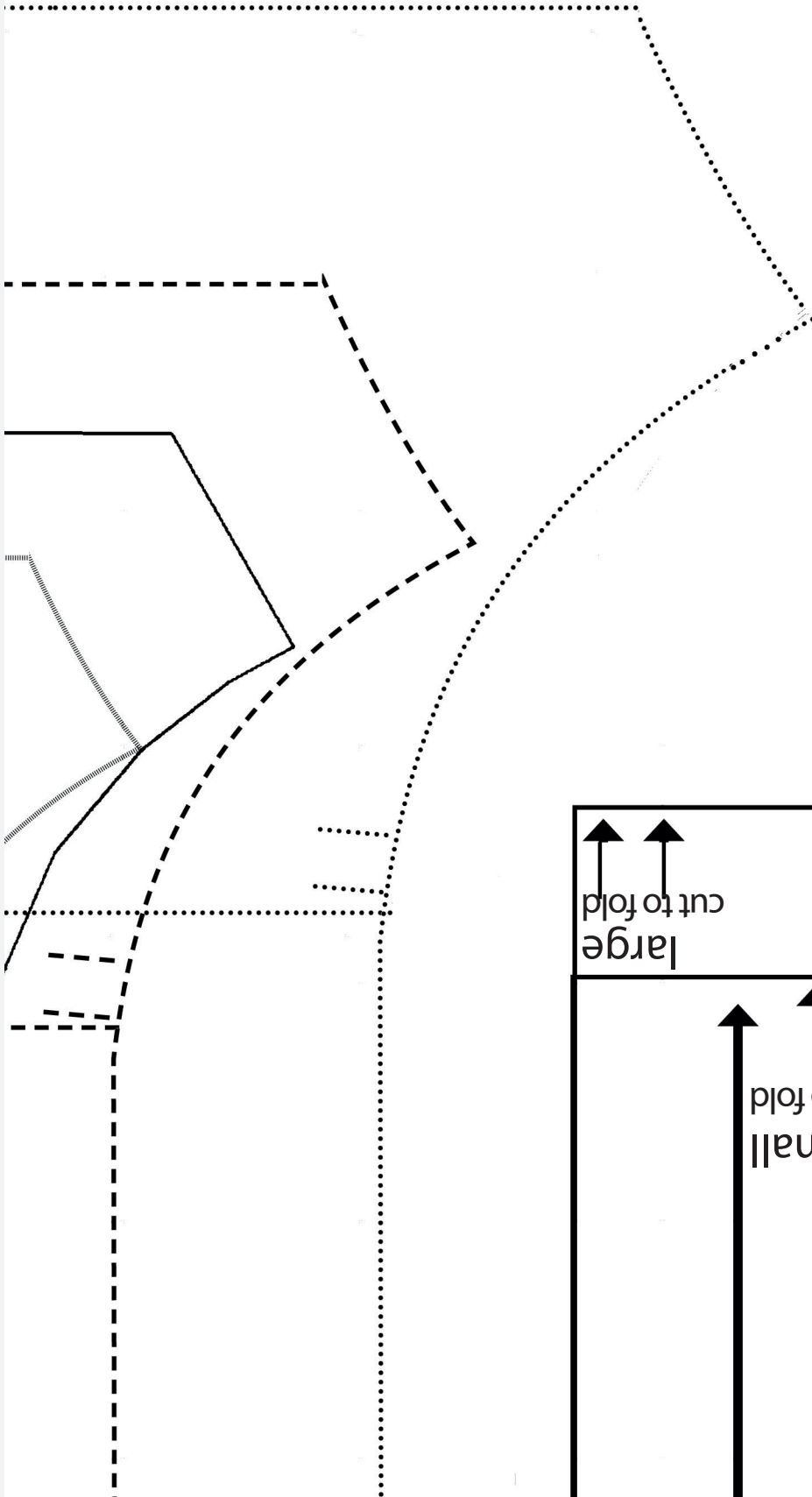

TEST SQUARE
10x10cm

Simply. **SEWING**

FRESH IDEAS WITH FABRIC

Use these templates to make the romper set.

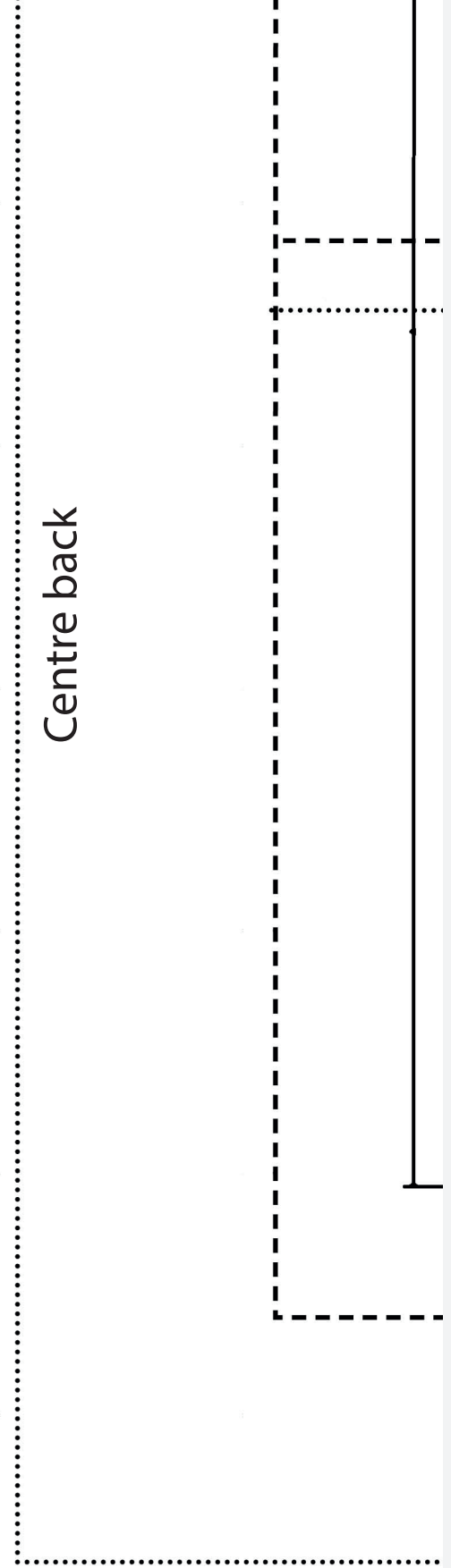

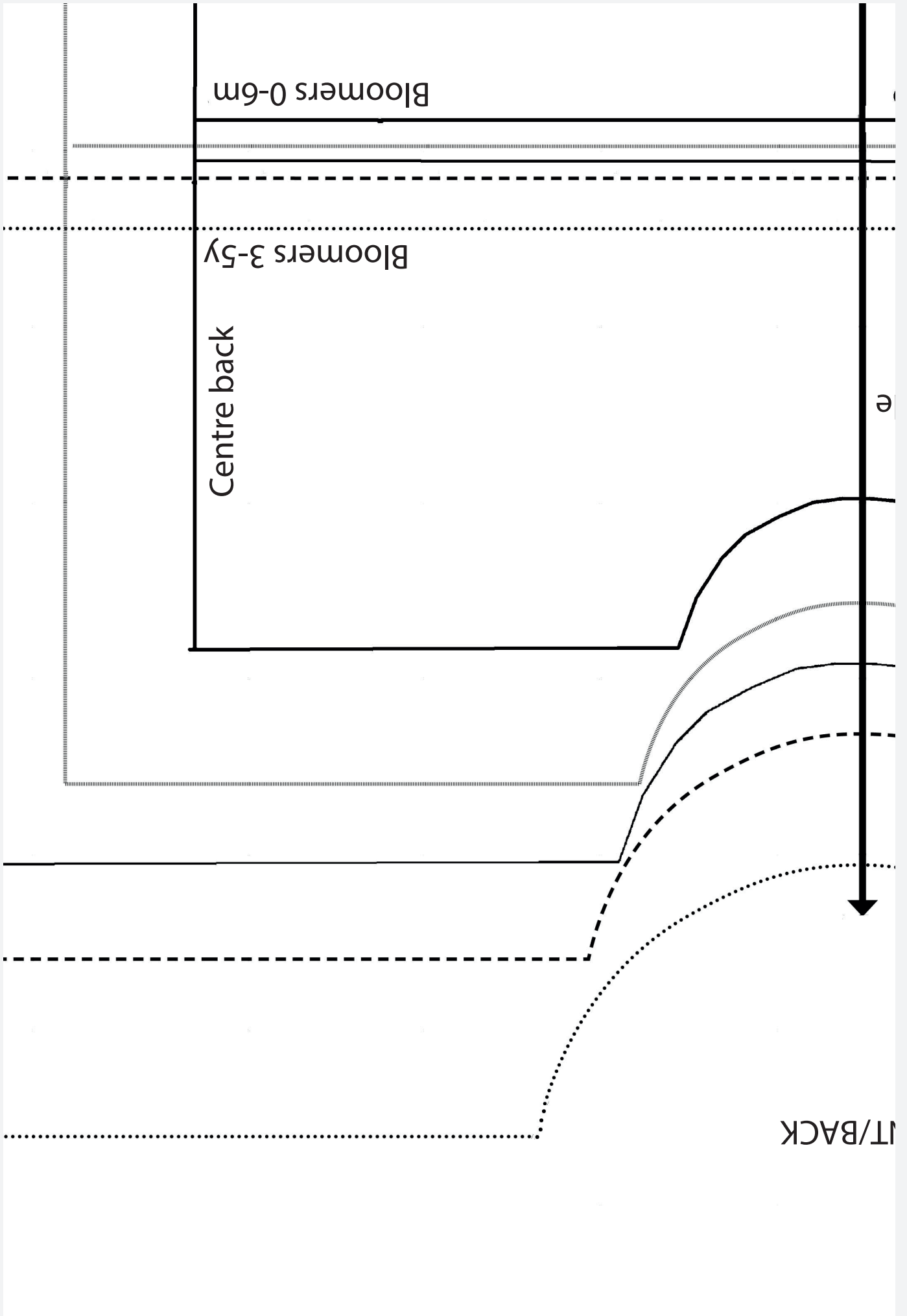

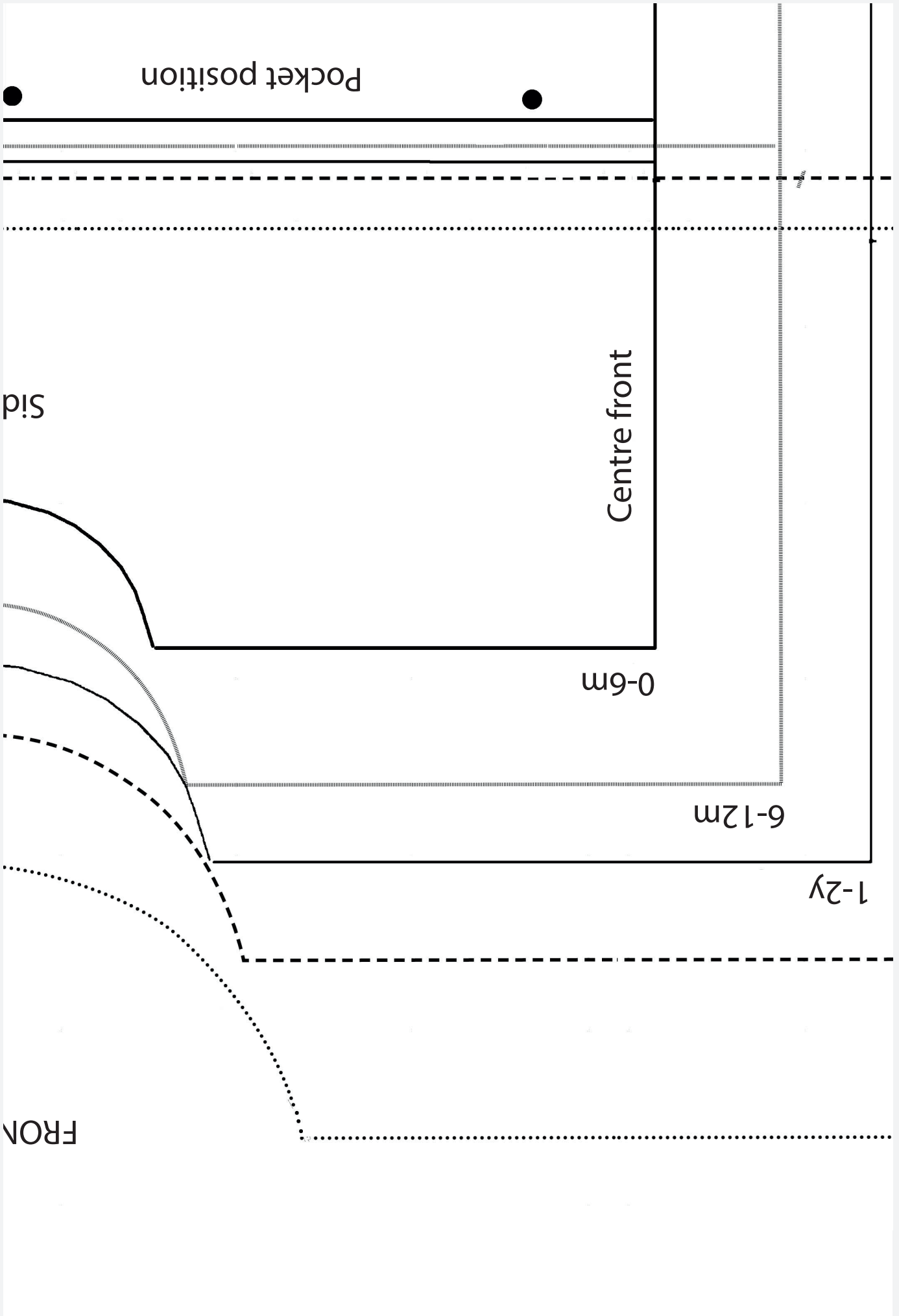

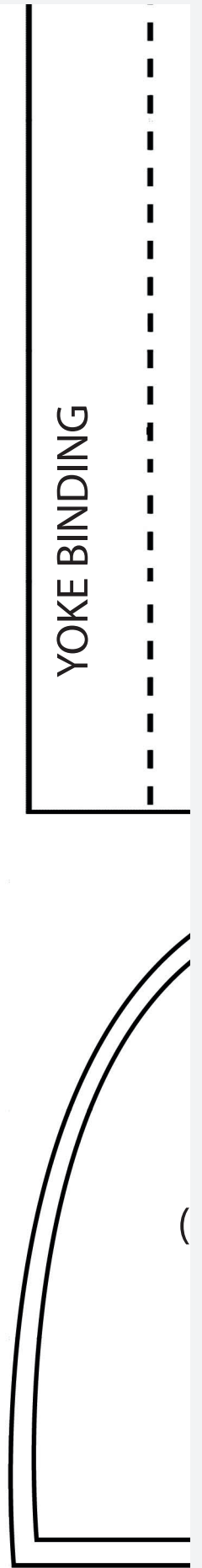
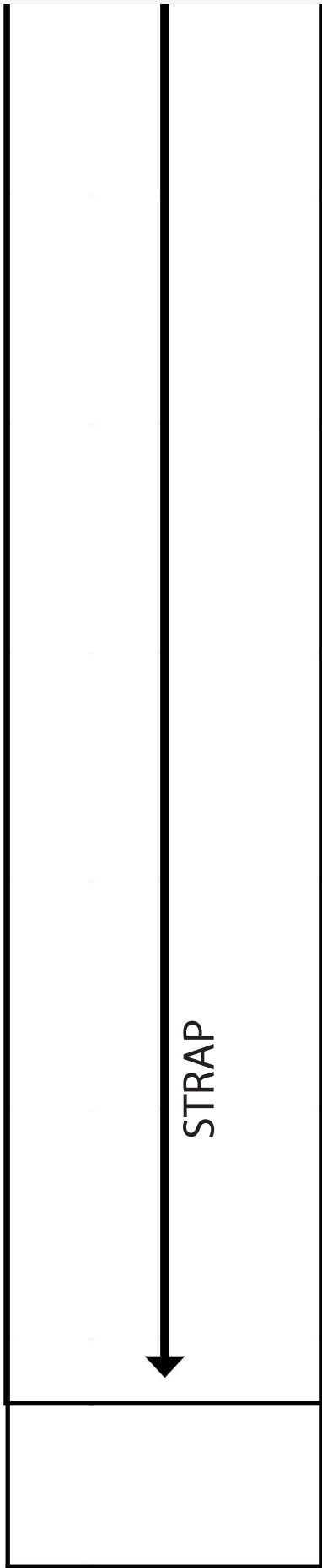
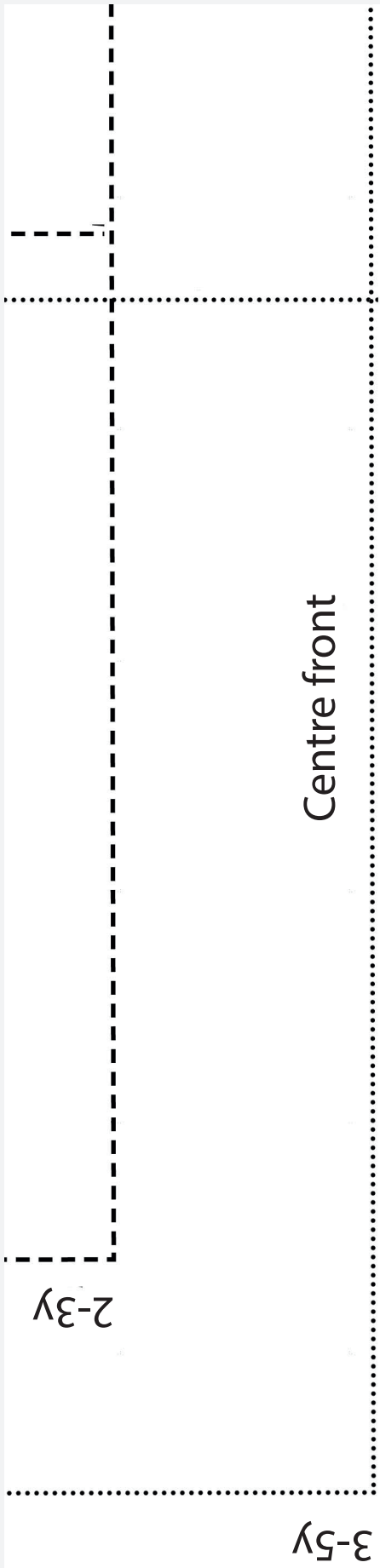

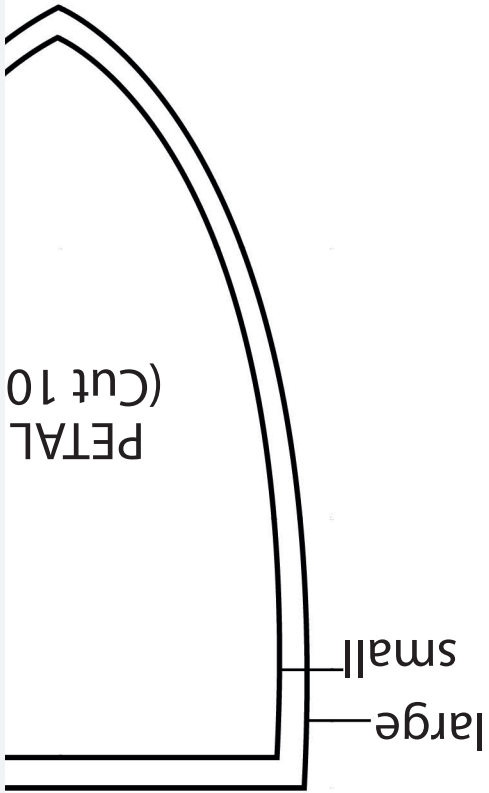
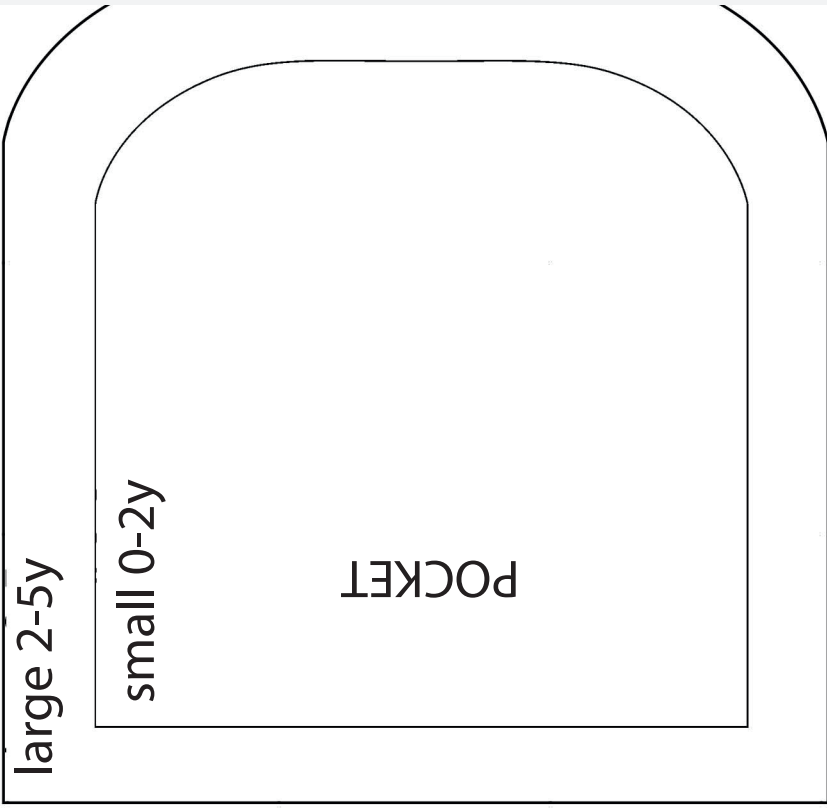



ROMPER SET

the designer of the
without permission,
a third party website,
copying is illegal.

Thank you for making these projects from *Simply Sewing*. The copyright for these templates belongs to the project. They work hard to create projects for you to enjoy, so please don't re-sell or distribute their work or copy it multiple times without our permission. Copyright law protects creative work and unauthorized use is prohibited. We really appreciate your help. Find more templates and ideas at www.simplysewingmag.com

CAT BED
EAR

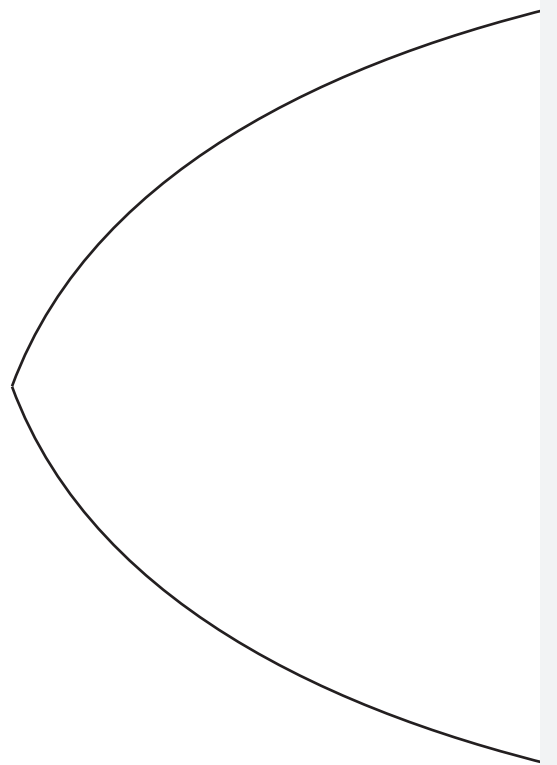

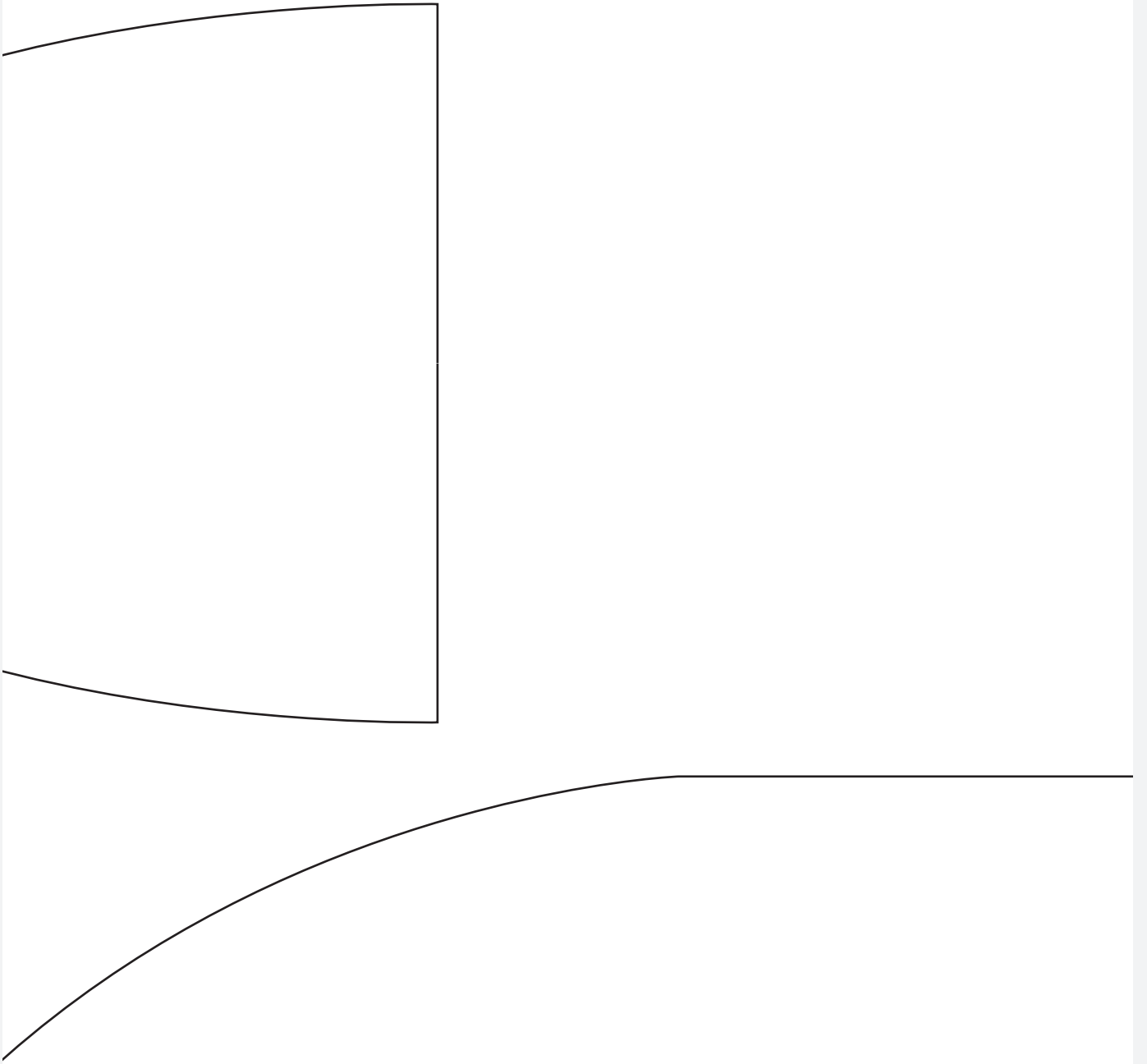

Thank you for making these projects from *Simply Sewing*. The copyright for these templates belongs to project. They work hard to create projects for you to enjoy, so please don't re-sell or distribute or copy it multiple times without our permission. Copyright law protects creative work and we really appreciate your help. Find more templates and ideas at www.simplysewingmag.com

TEST SQUARE
10x10cm

Simply. **SEWING**

FRESH IDEAS WITH FABRIC

Use these templates to make the cat bed.

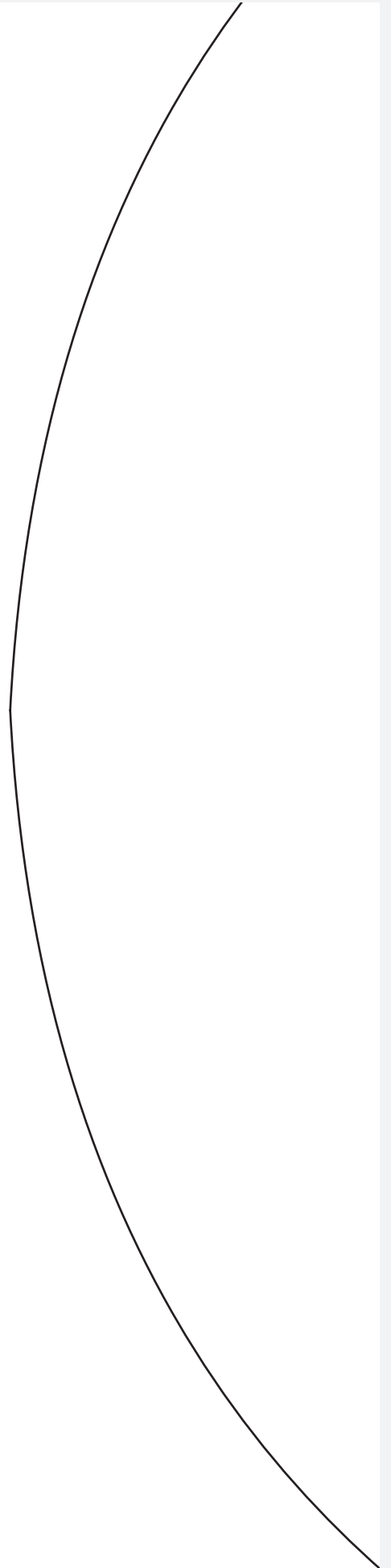

JK

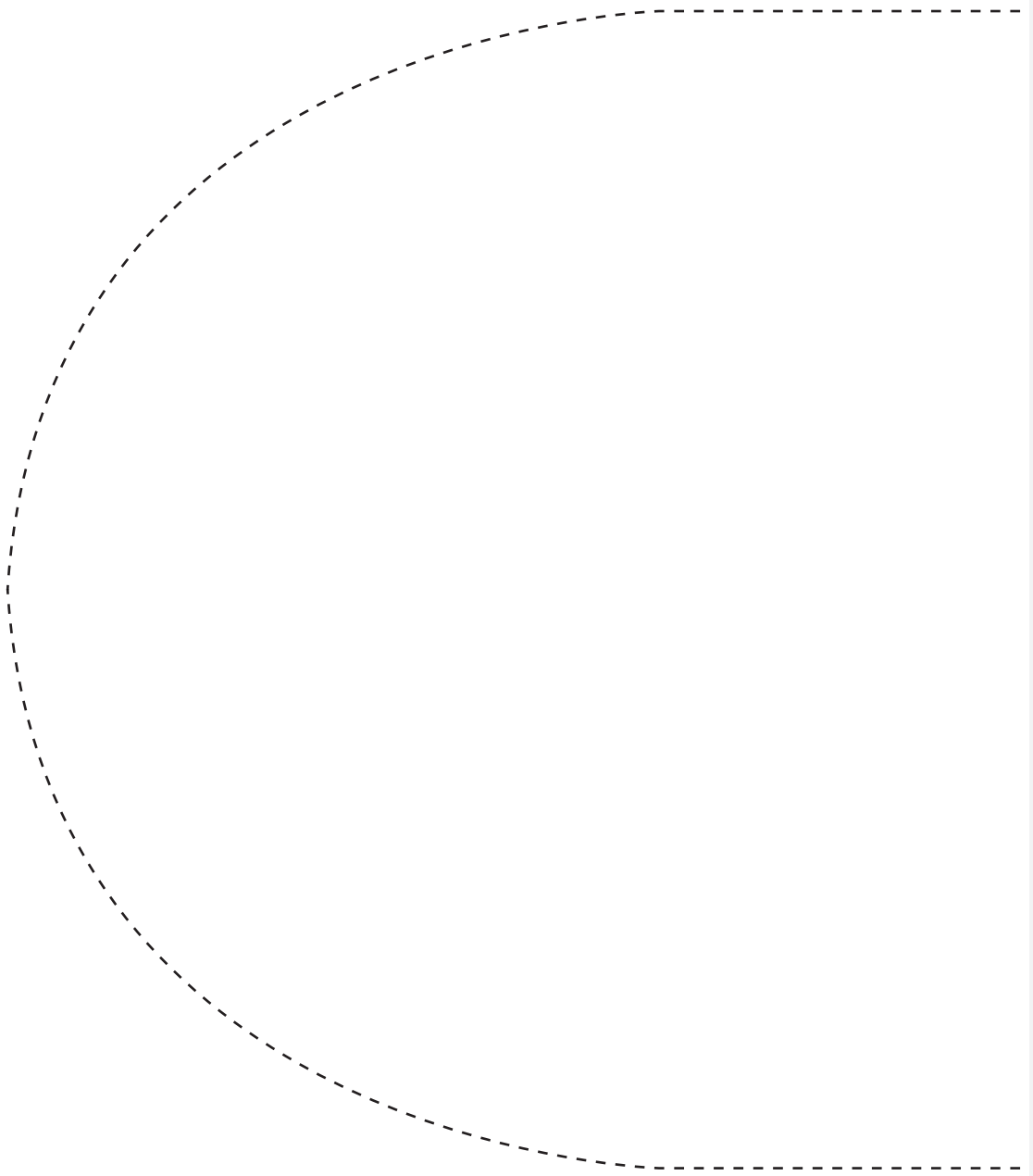

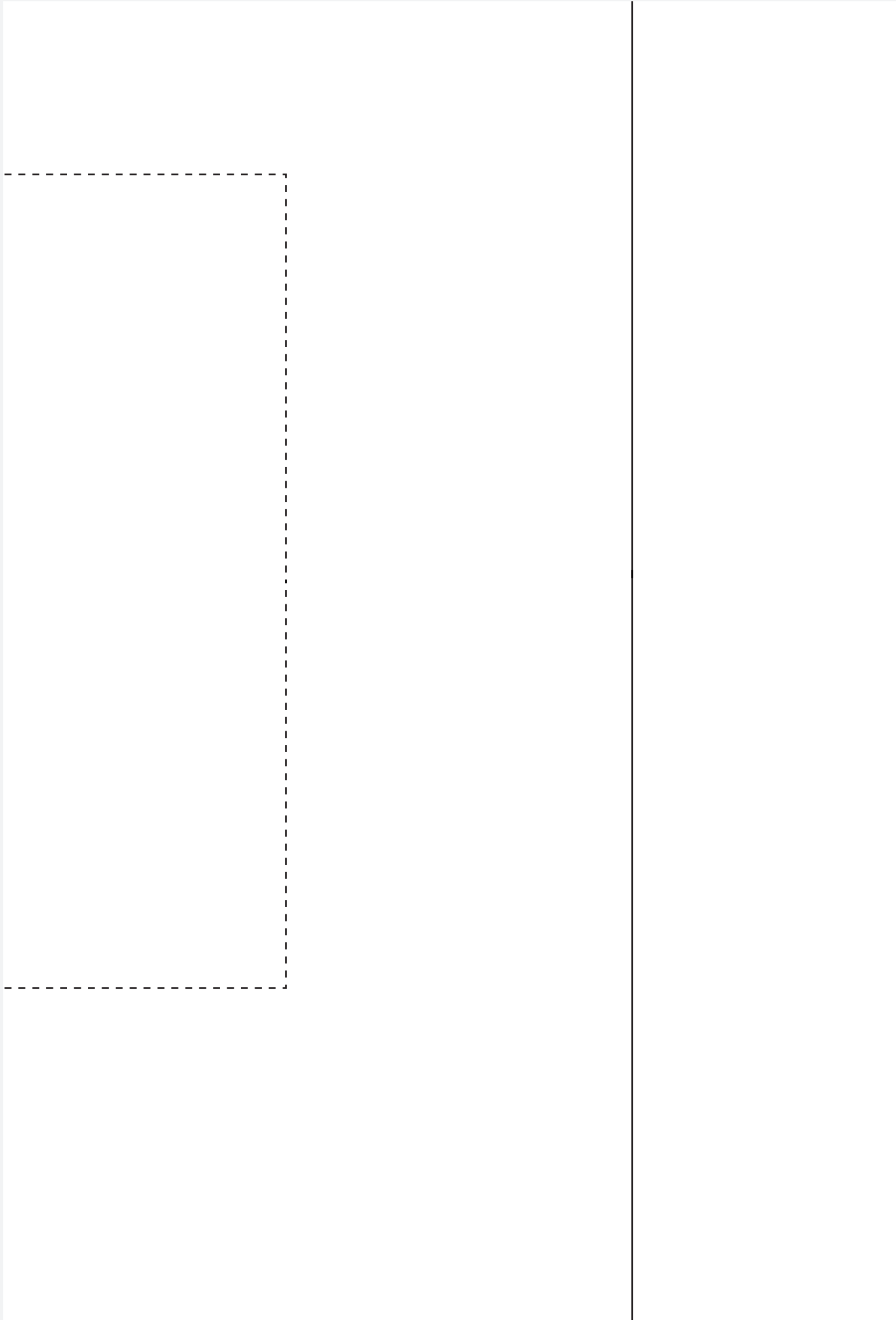



CAT BED
FRONT/BACK



