

TEMPLATES

Here are the templates you will need to make some of the projects in *Simply Sewing* issue 42.

BRIDAL GIFTS CARD



CONFETTI BAG

Celebrate

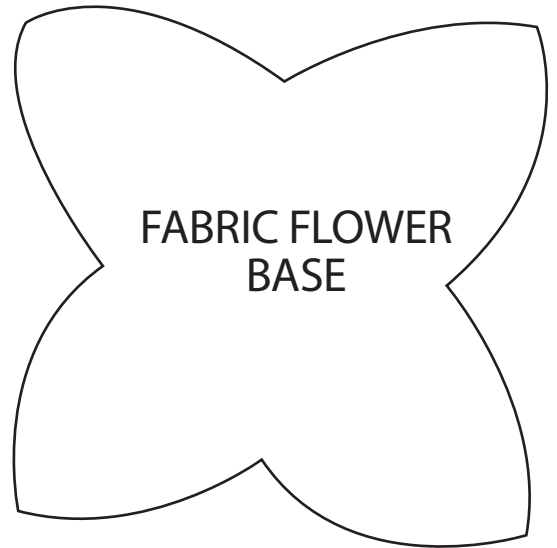
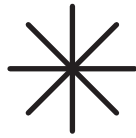

FABRIC FLOWER
BASE

BRIDAL GIFTS



BUTTONHOLE
FLOWER BASE

CONFETTI BAG

Throw me

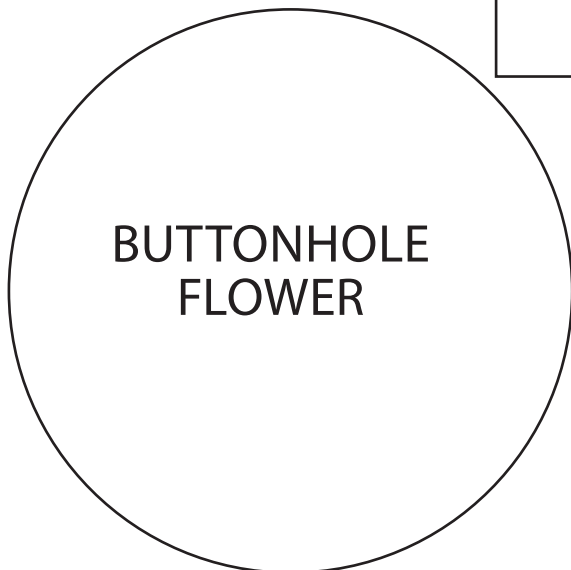

BUTTONHOLE
FLOWER

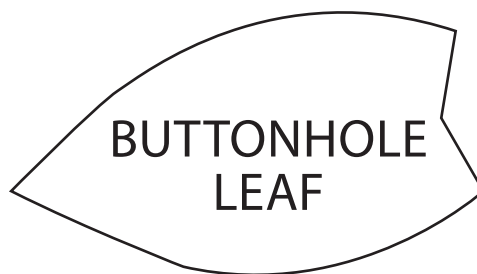

BUTTONHOLE
LEAF

CONFETTI BAG

Sprinkle me



FABRIC FLOWER
LEAF

TEST SQUARE
10x10cm



iv

a

BRIDAL GIFTS
RING CUSHION
(ABOVE) AND
BUNTING

evr

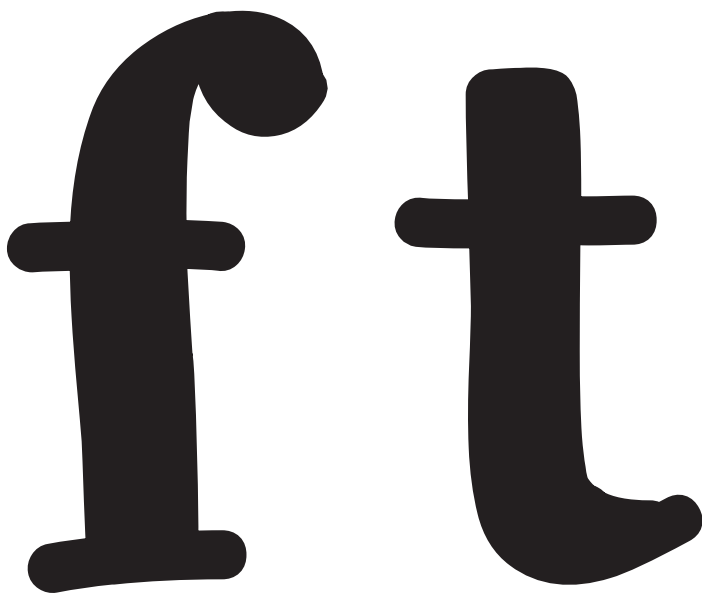
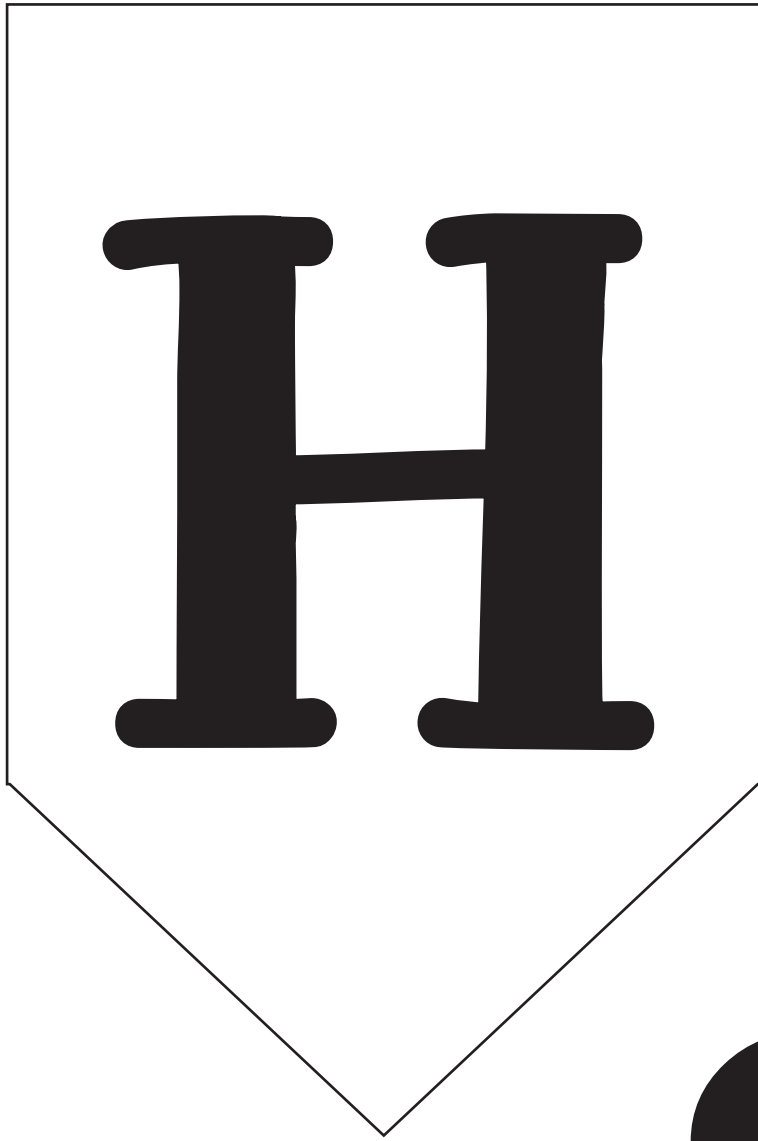

BRIDAL GIFTS

CONFETTI BAG

DIAGRAMS

LINING

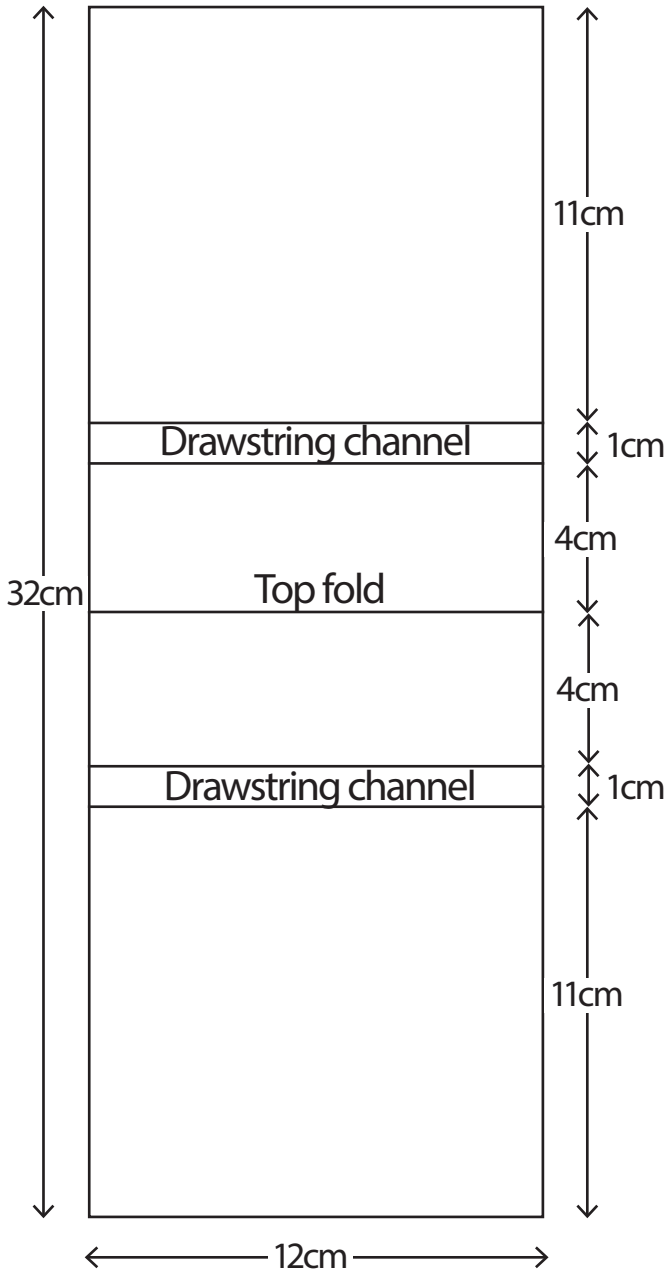

OUTER

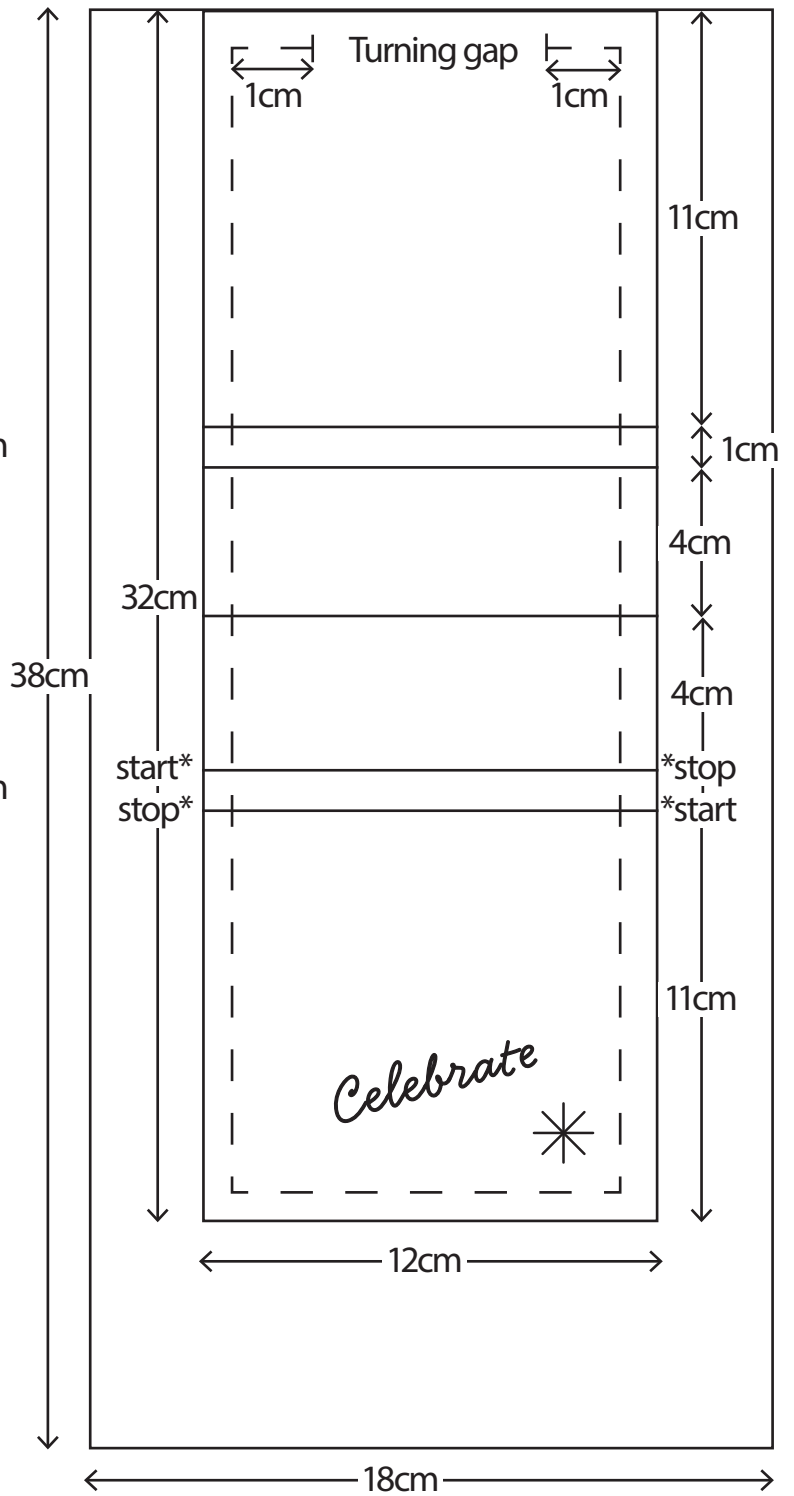

STITCH
FERN STITCH

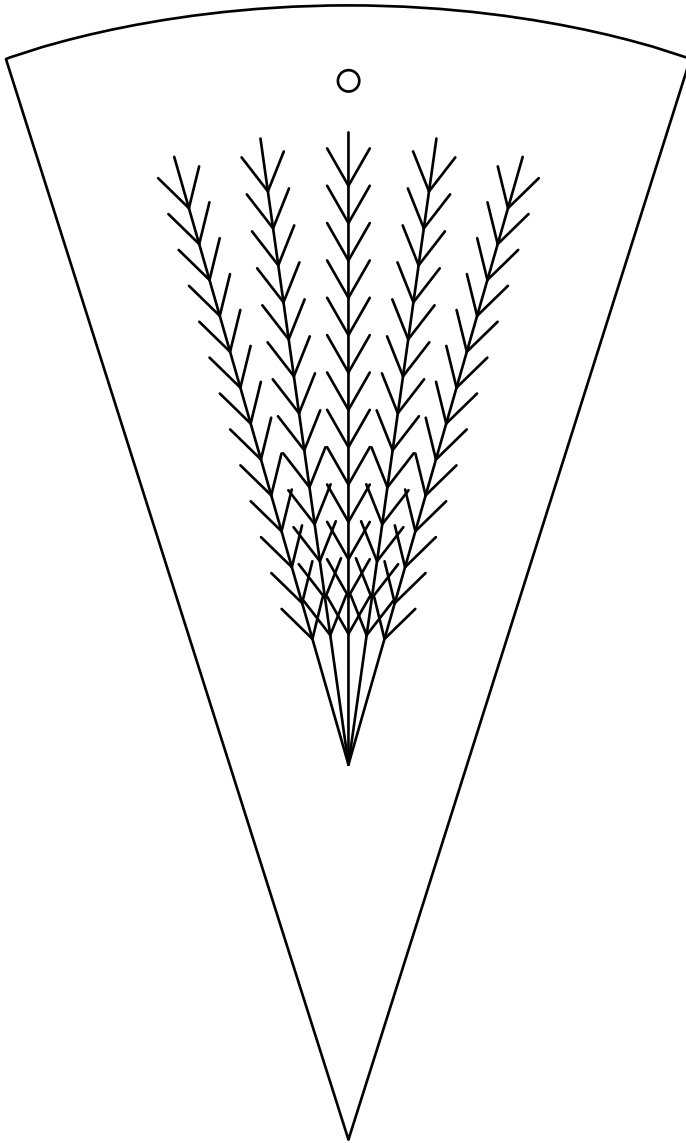

WORKSHOP
SHELL



NECKLACE
STRAP

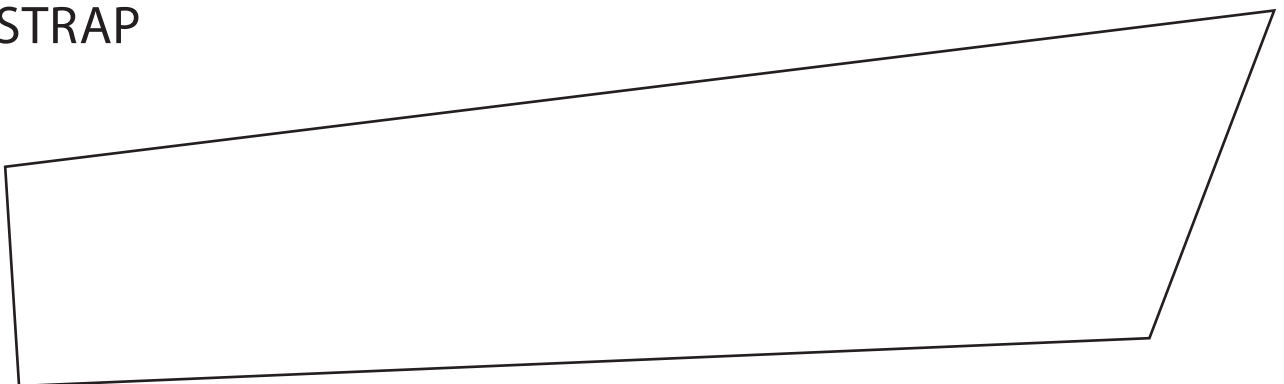

PIG TOY

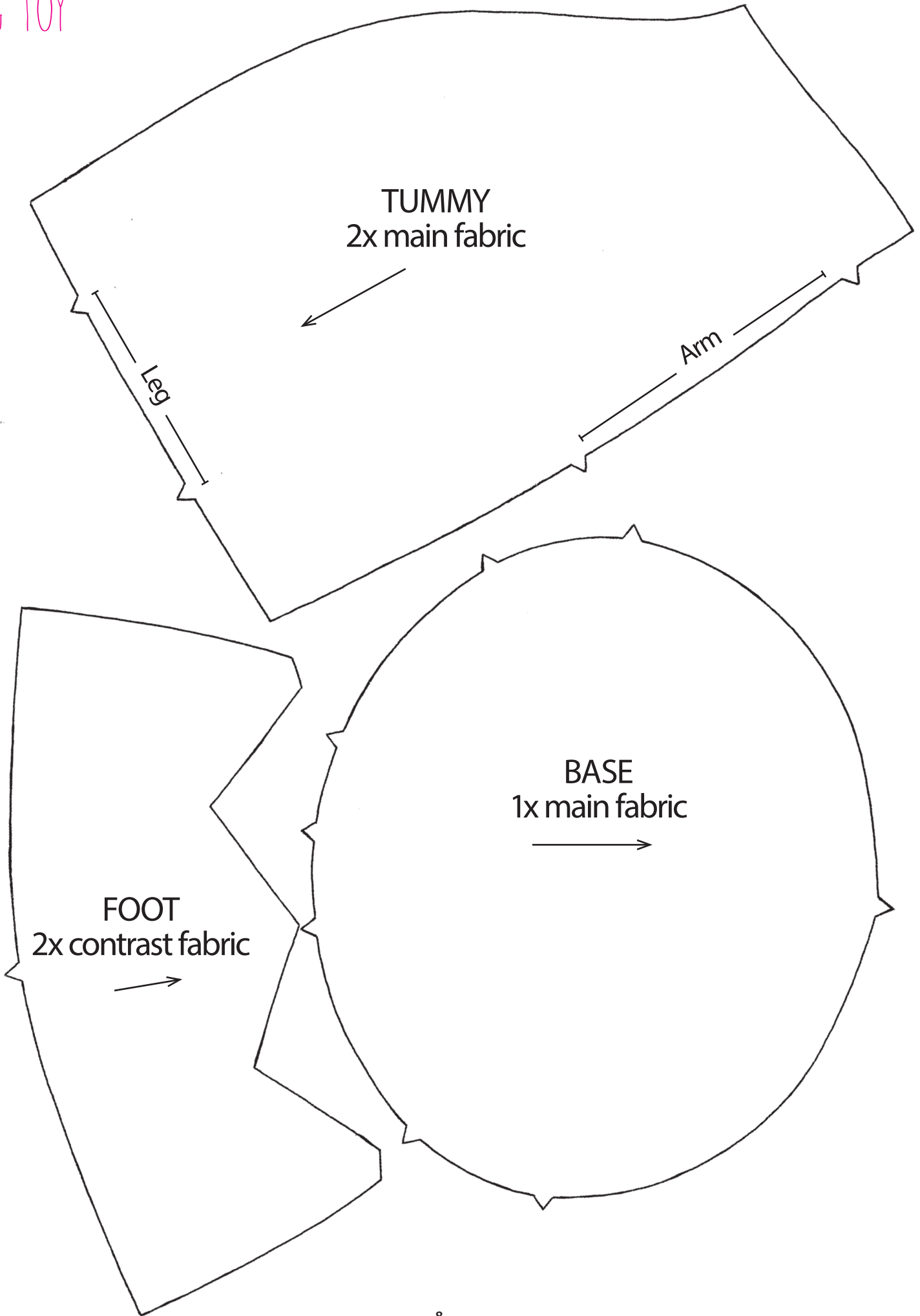

PIG TOY

BACK BODY
2x main fabric



TAIL
1x contrast fabric



LEG
2x main fabric

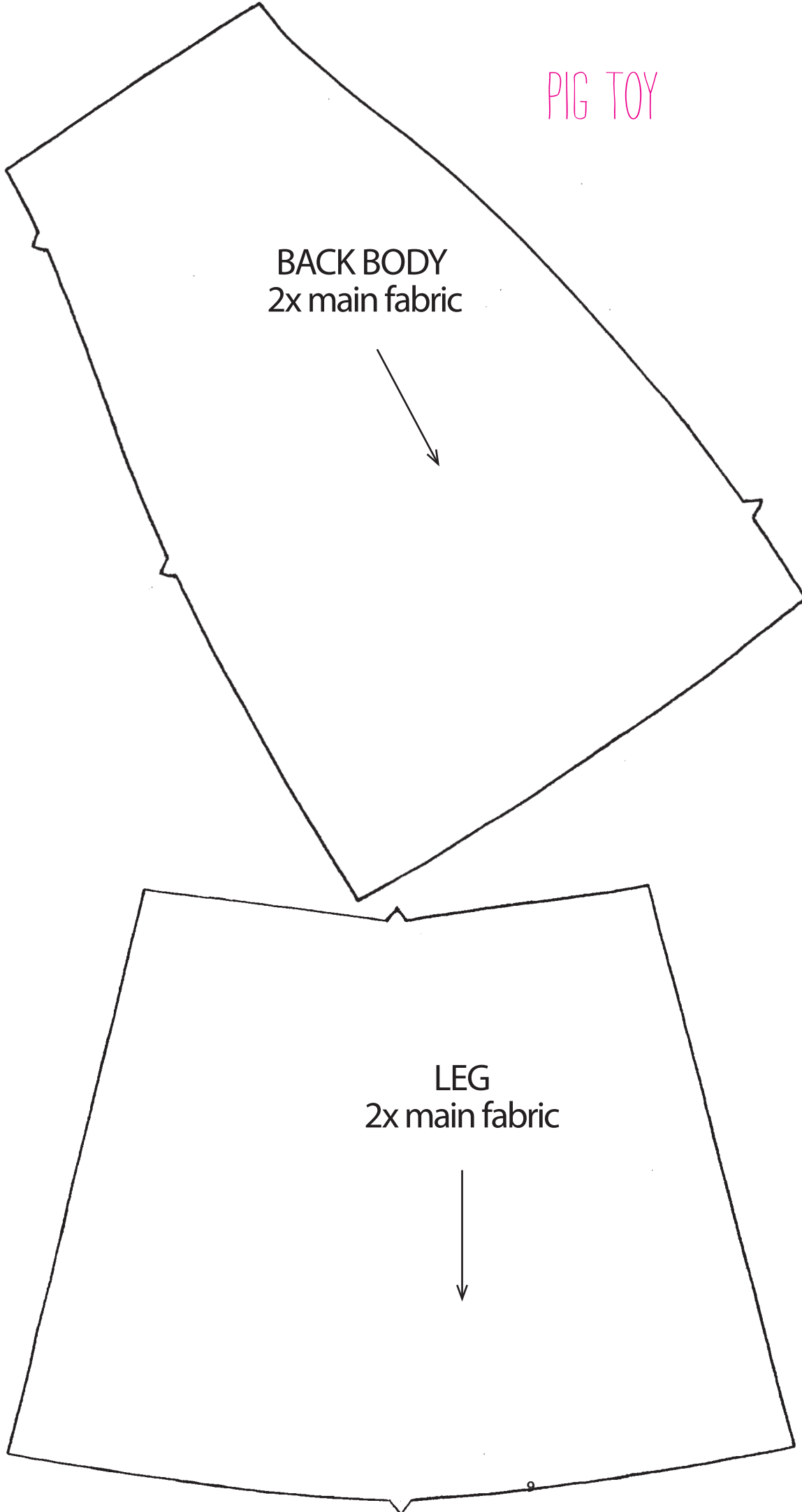

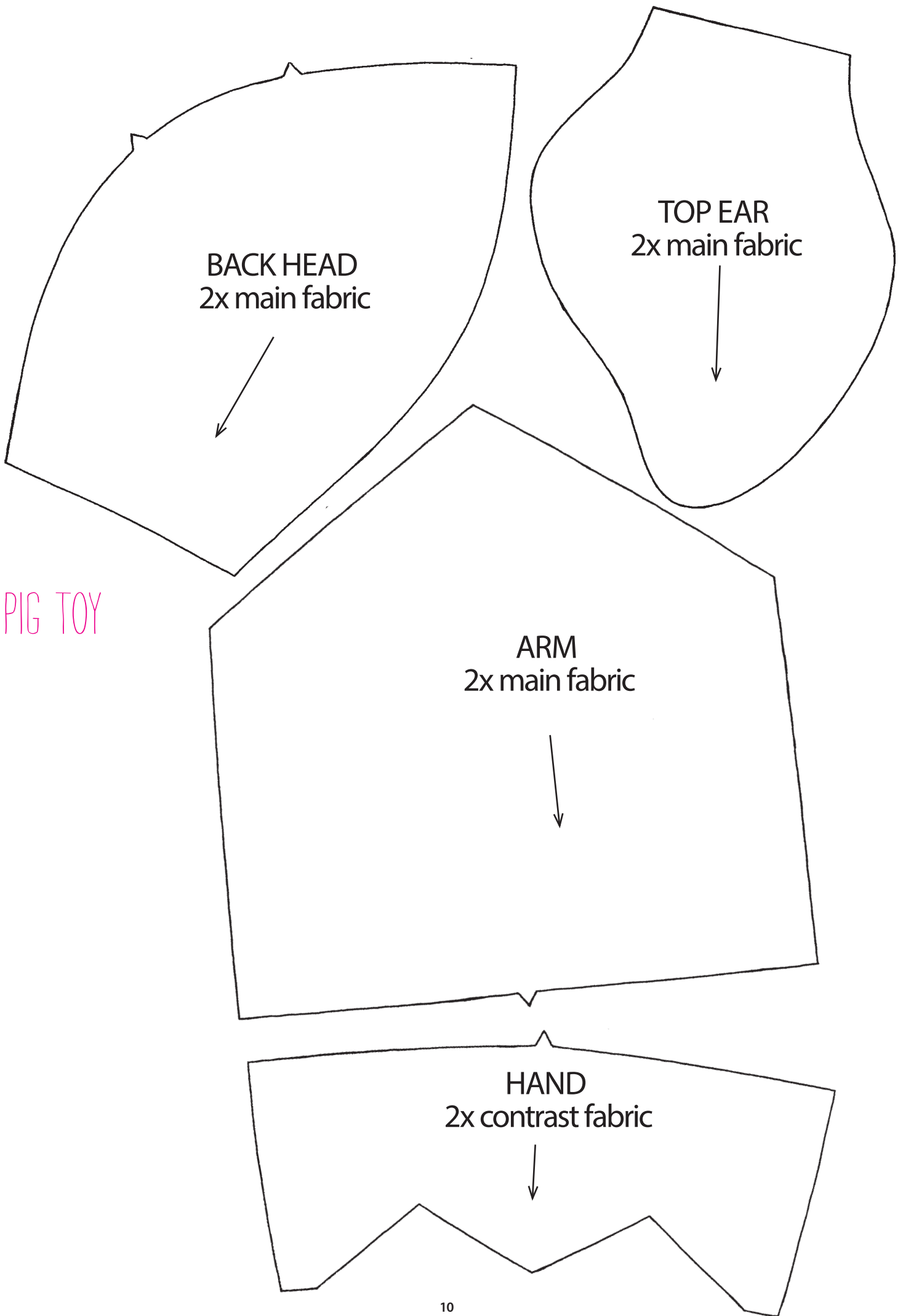

BACK HEAD
2x main fabric

TOP EAR
2x main fabric

ARM
2x main fabric

HAND
2x contrast fabric

PIG TOY

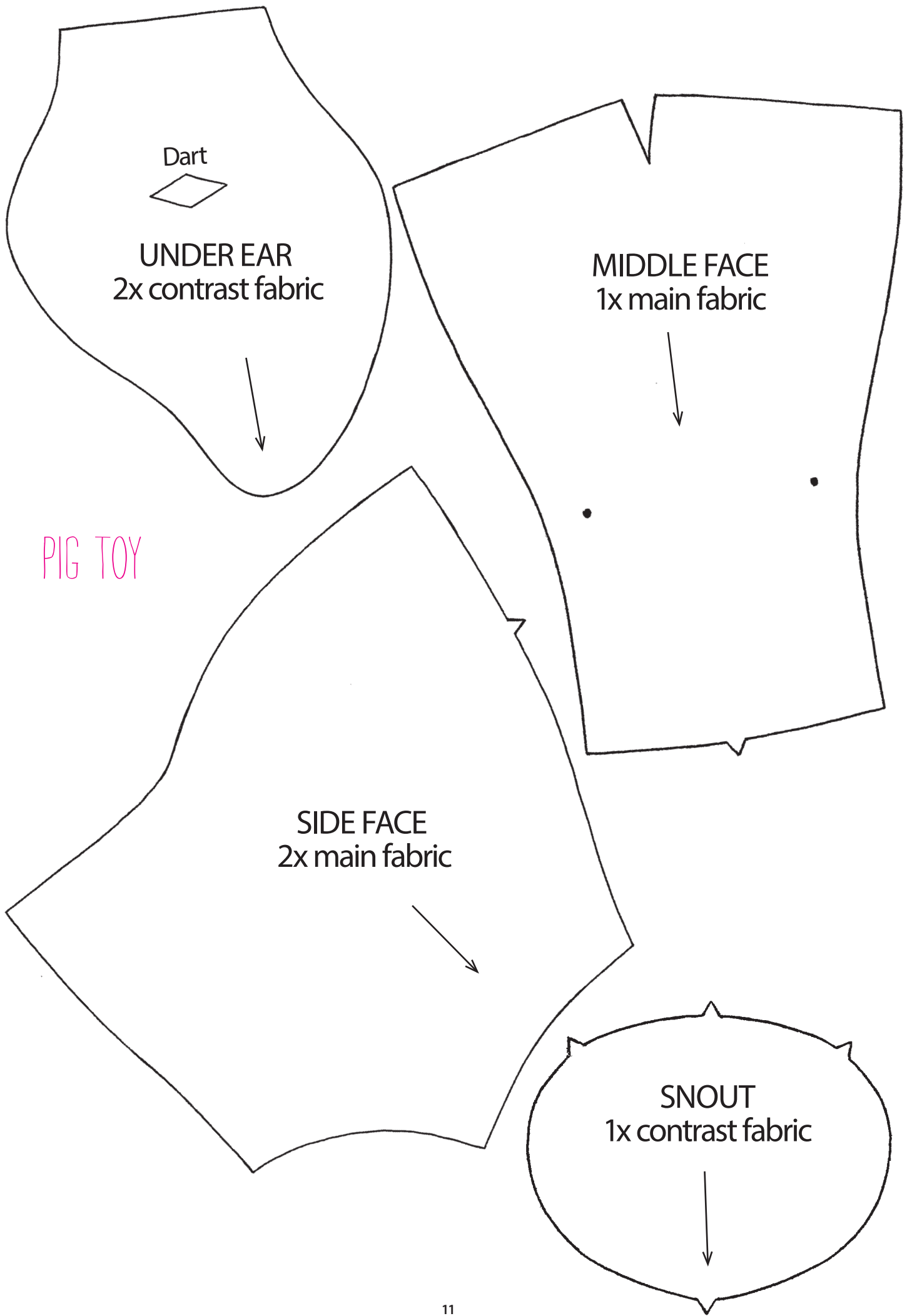

PIG TOY

CLUTCH
BACK/FLAP

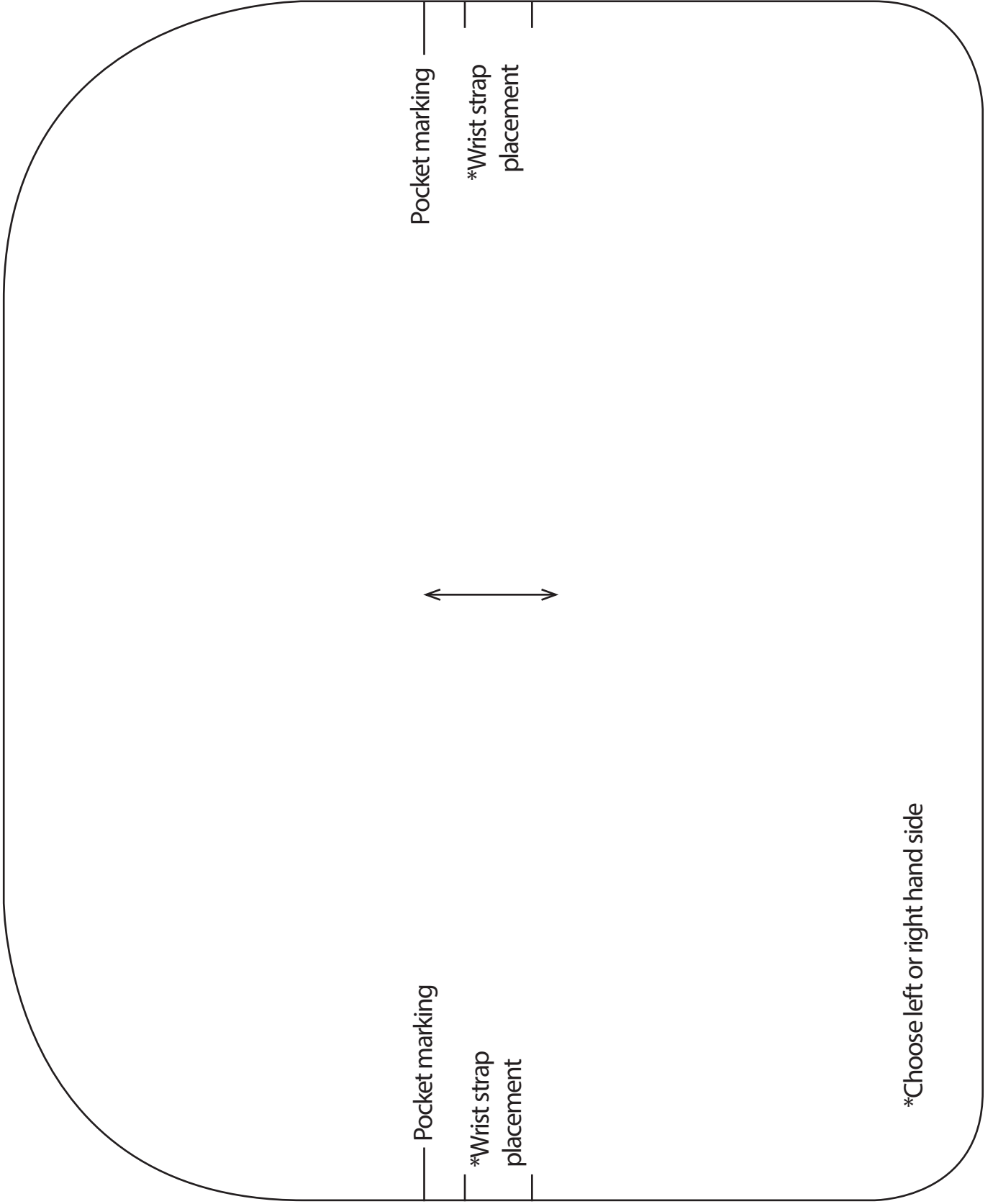

CLUTCH
POCKET

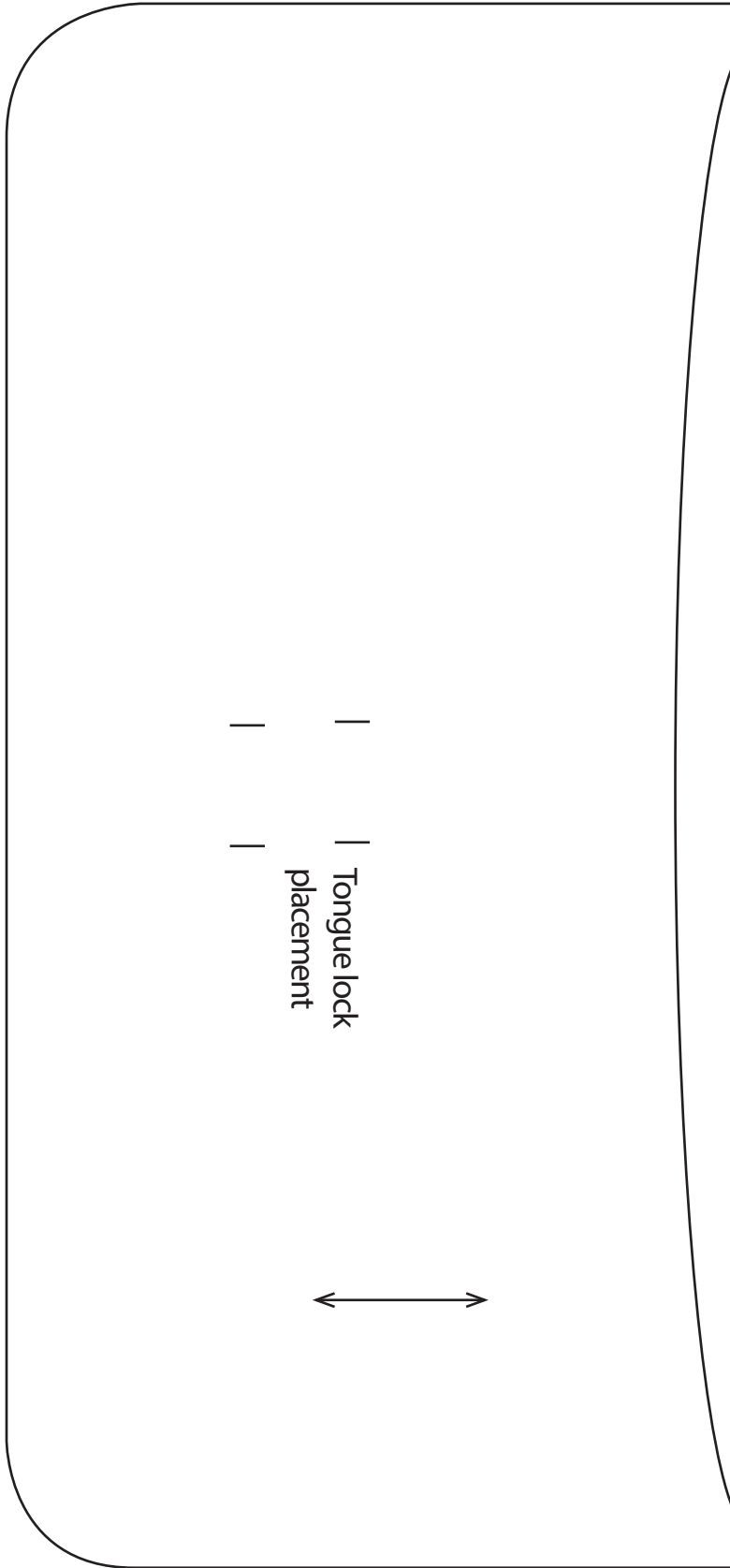

CLUTCH FRONT

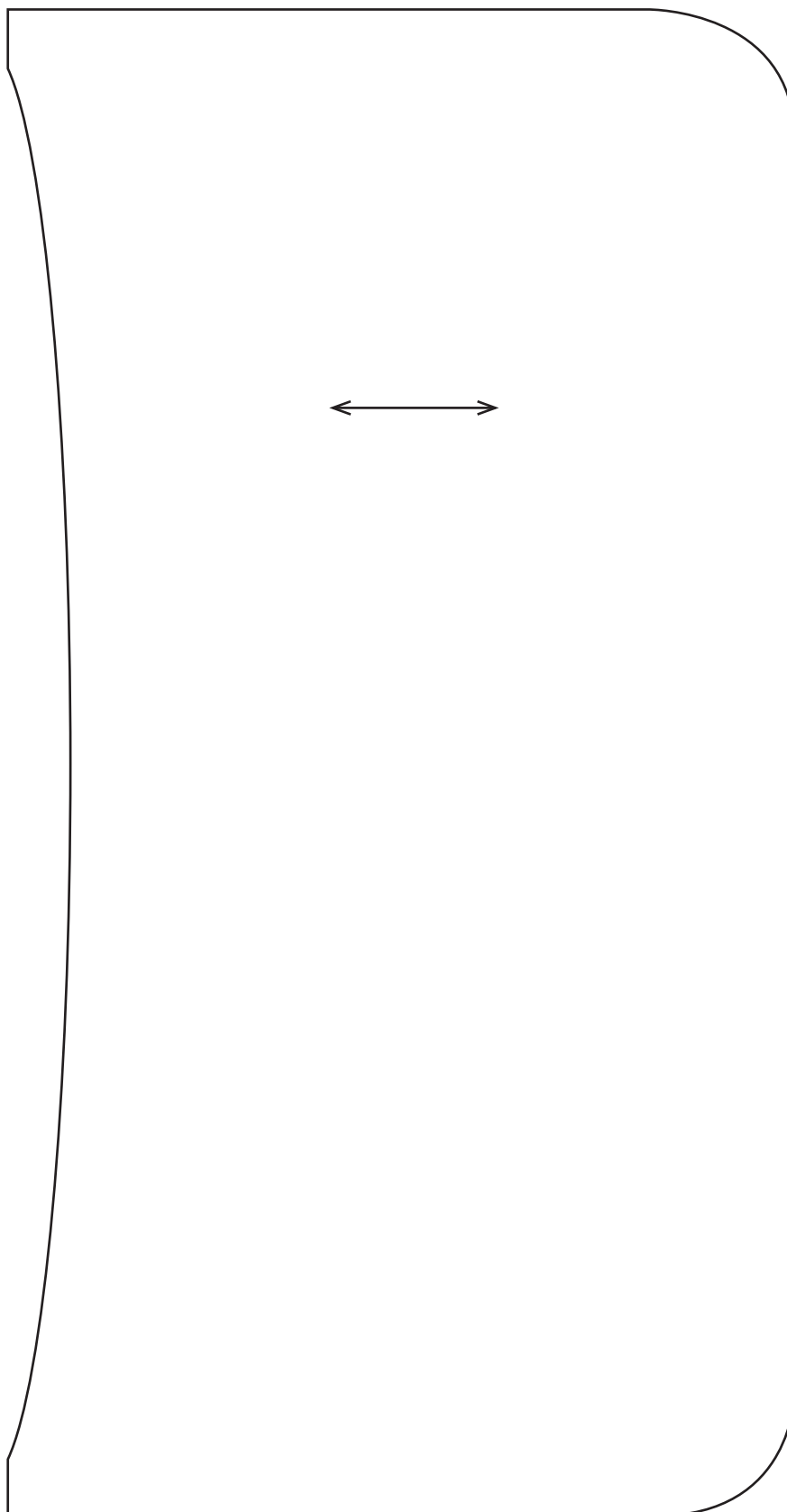

Thank you for making these projects from *Simply Sewing*.
The copyright for these templates belongs to the designer of the project. They work hard to create projects for you to enjoy, so please don't re-sell or distribute their work without permission.
Please do not make any part of the templates or instructions available to others through your website or a third party, or copy it multiple times without our permission.
Copyright law protects creative work and unauthorised copying is illegal.
We appreciate your help.