

TODAY'S
QUILTER
Create beautiful quilts for your home

FOUNDATION PAPER PIECING TEMPLATES

by Lynne Goldsworthy

TEMPLATES ACTUAL SIZE
Includes seam allowances



Block 1 RADIATING SUNLIGHT

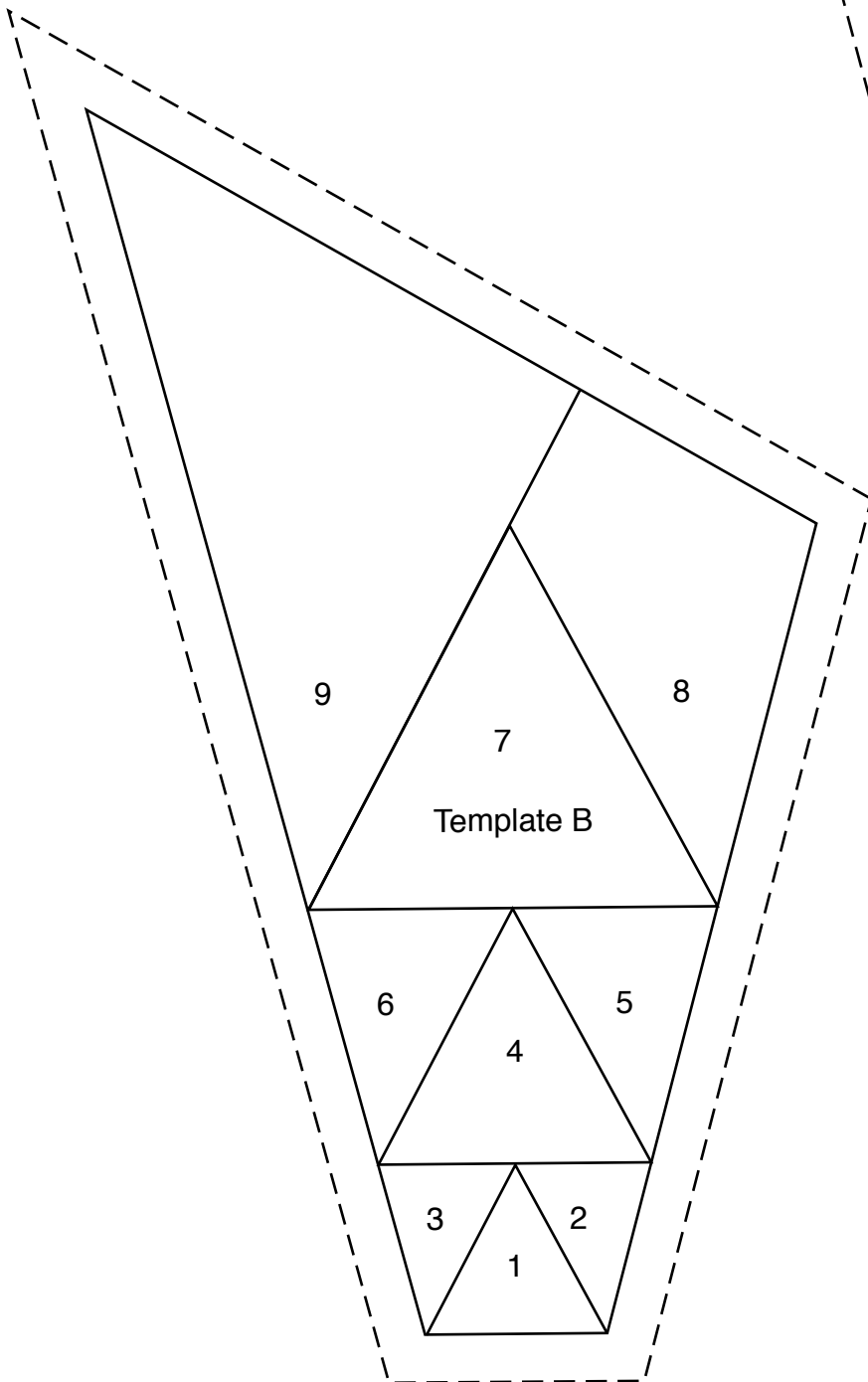
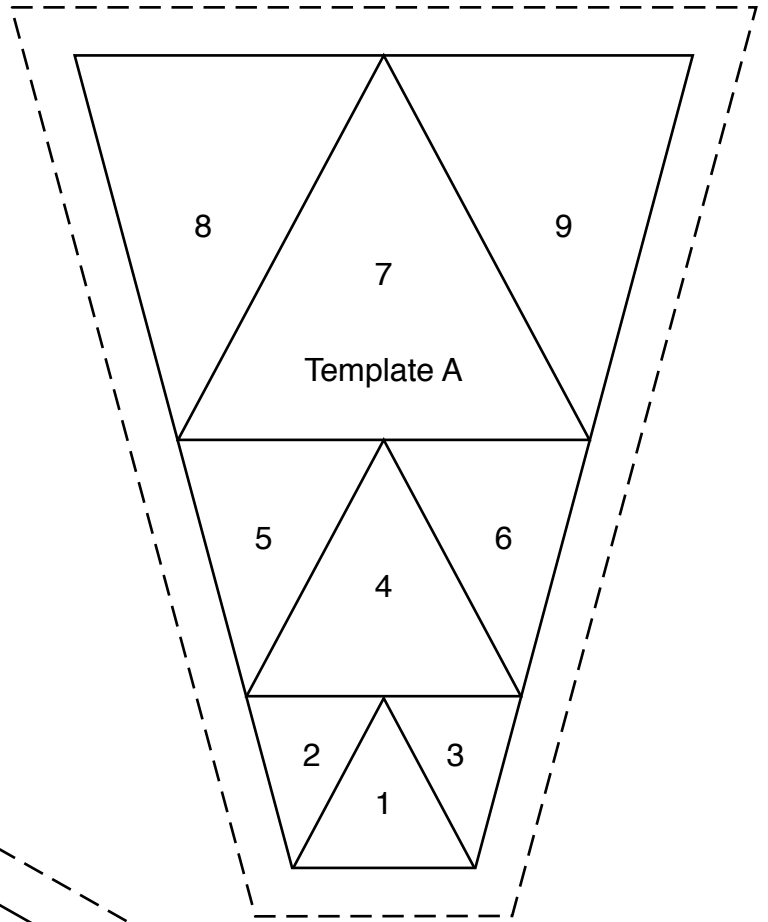

Block 1 RADIATING SUNLIGHT

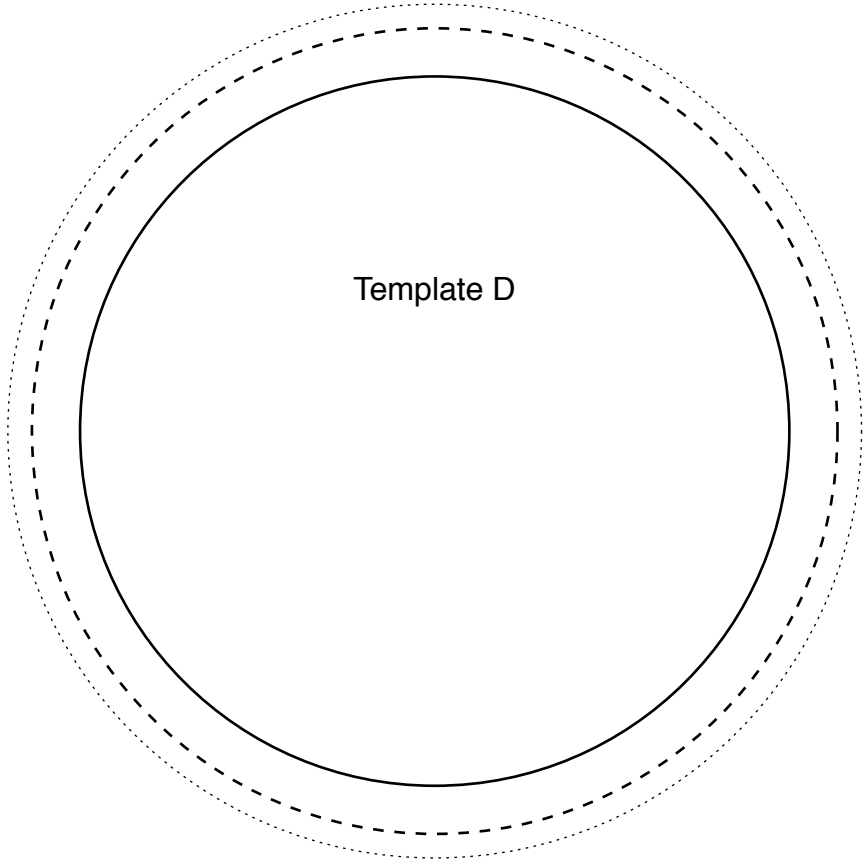
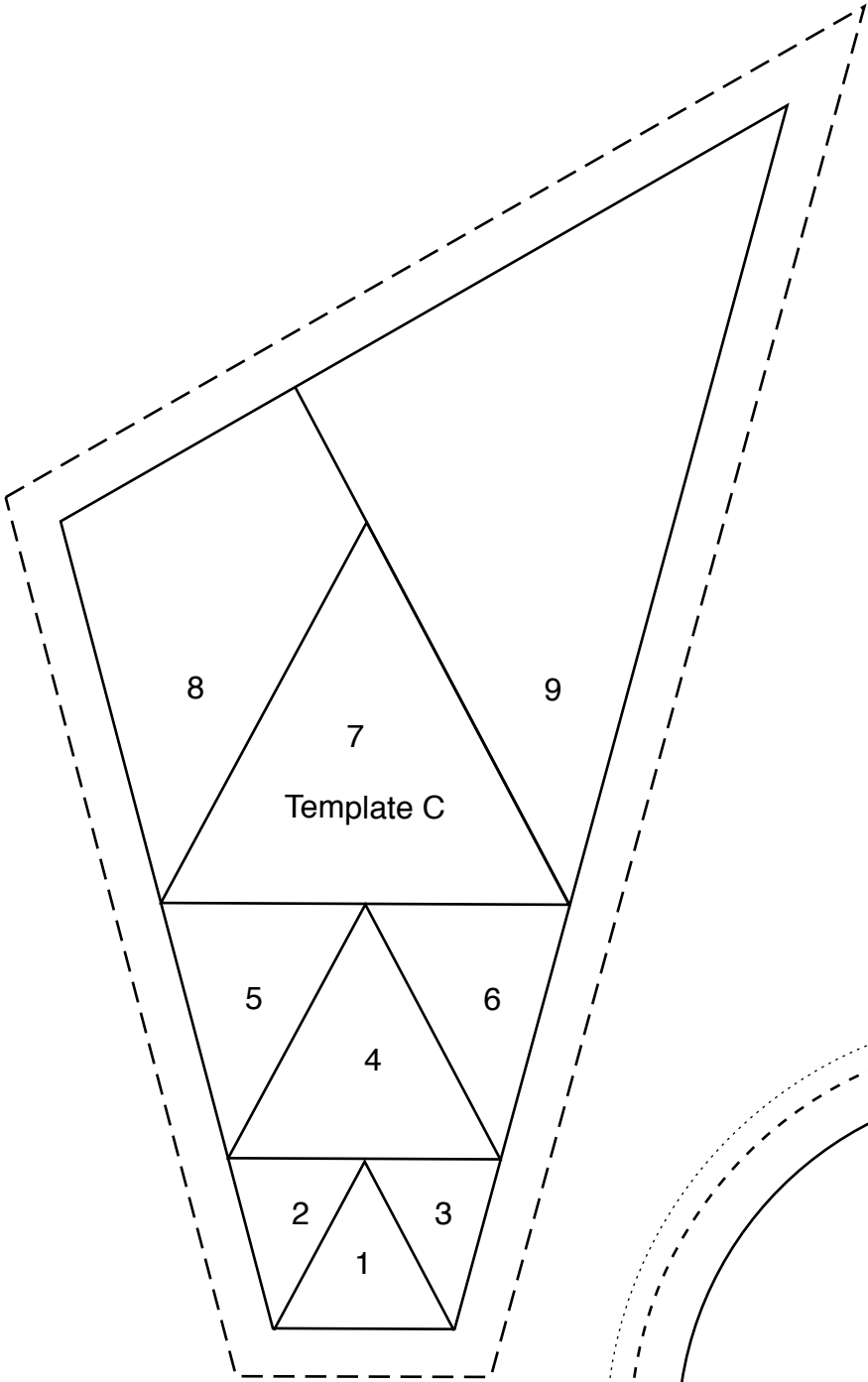

Block 2 SIMPLIFIED GEORGETOWN CIRCLE

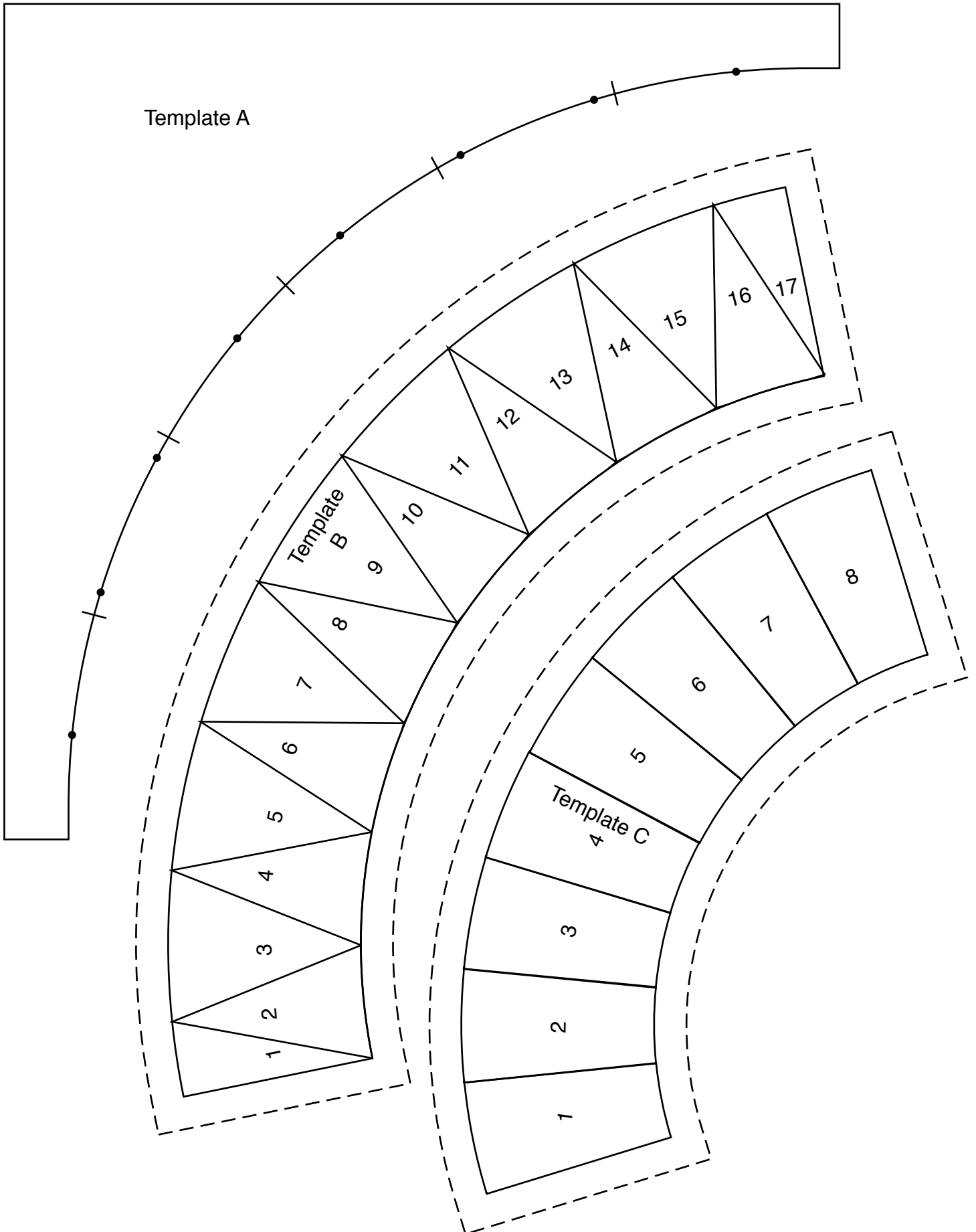

Block 2

SIMPLIFIED GEORGETOWN CIRCLE

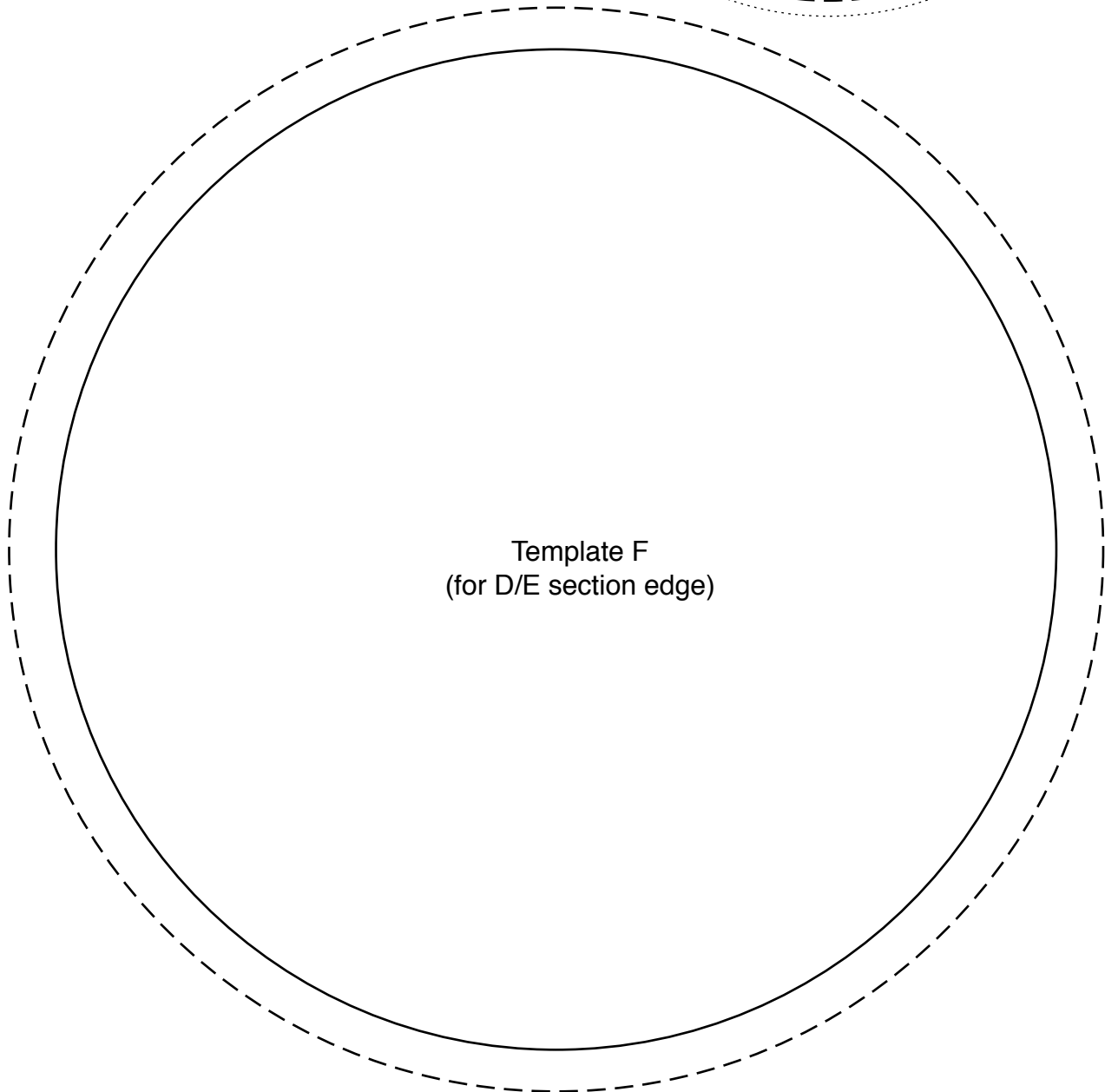
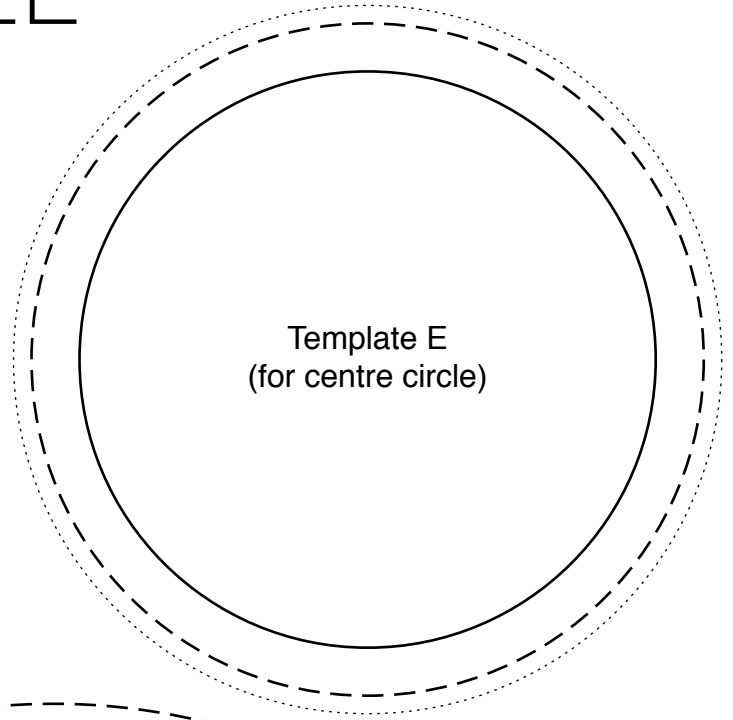
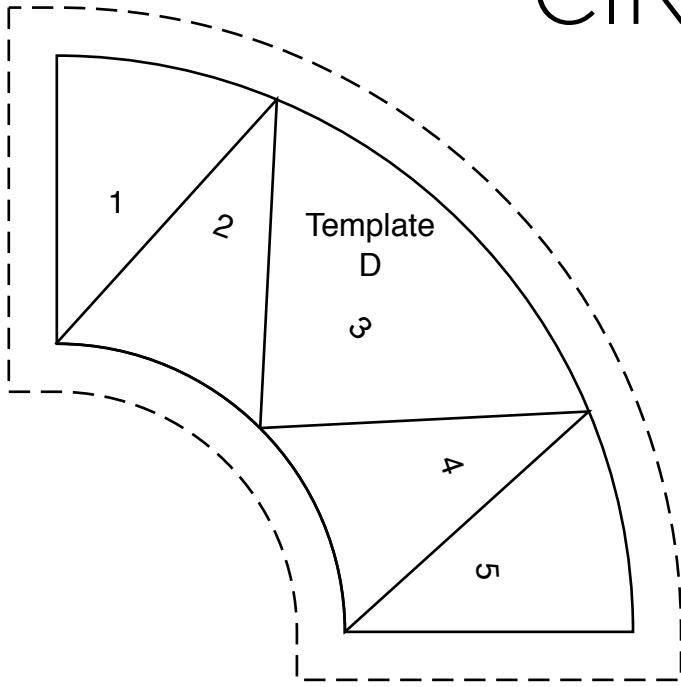

Block 3 TURNING SQUARES

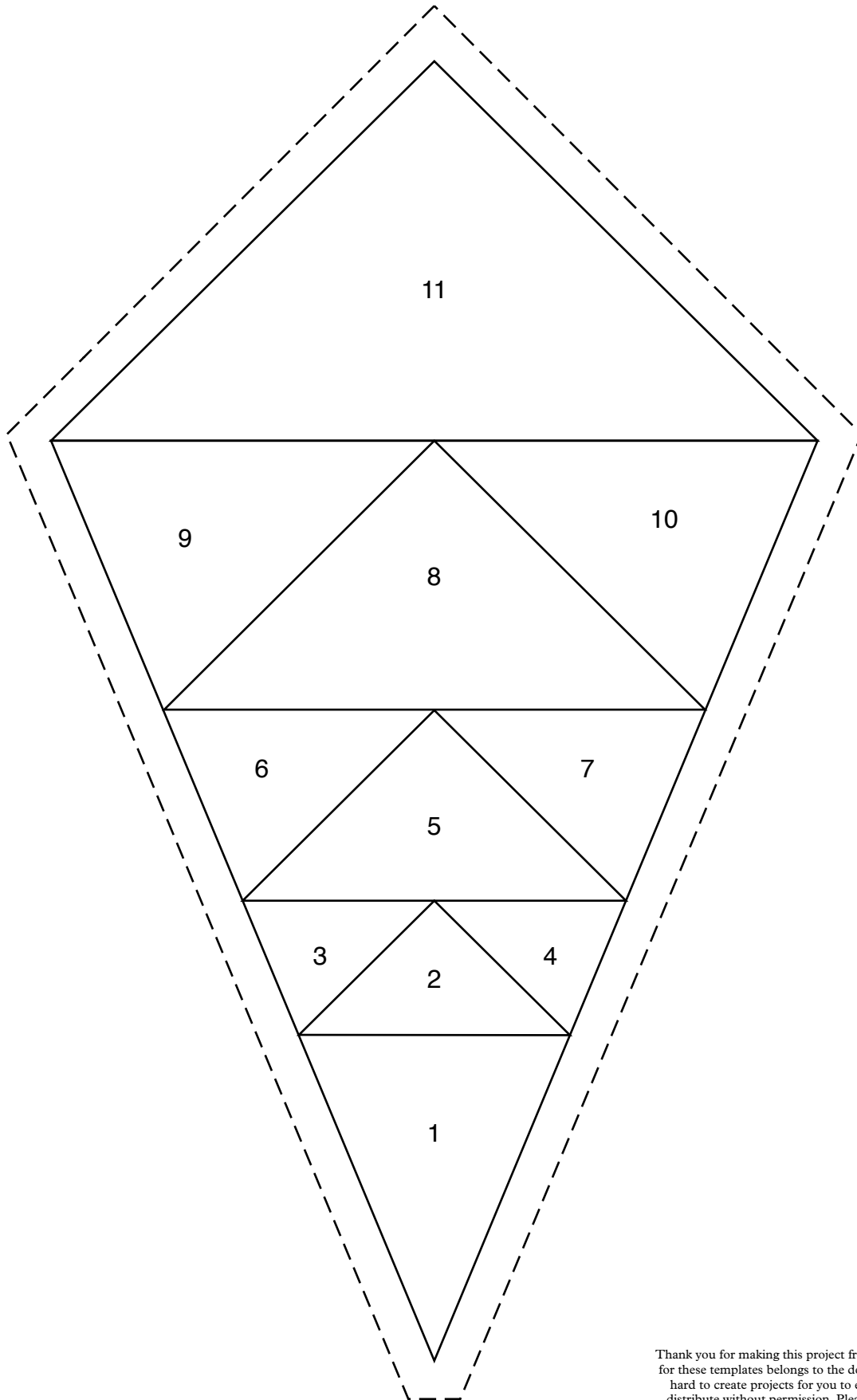

Thank you for making this project from *Today's Quilter*. The copyright for these templates belongs to the designer of the project. They work hard to create projects for you to enjoy, so please don't re-sell or distribute without permission. Please do not make any part of the templates or instructions available to others through your website or a third party website, or copy it multiple times without permission. Copyright law protects creative work and unauthorised copying is illegal. We appreciate your help.

Block 4 FLYING GEESE CIRCLE

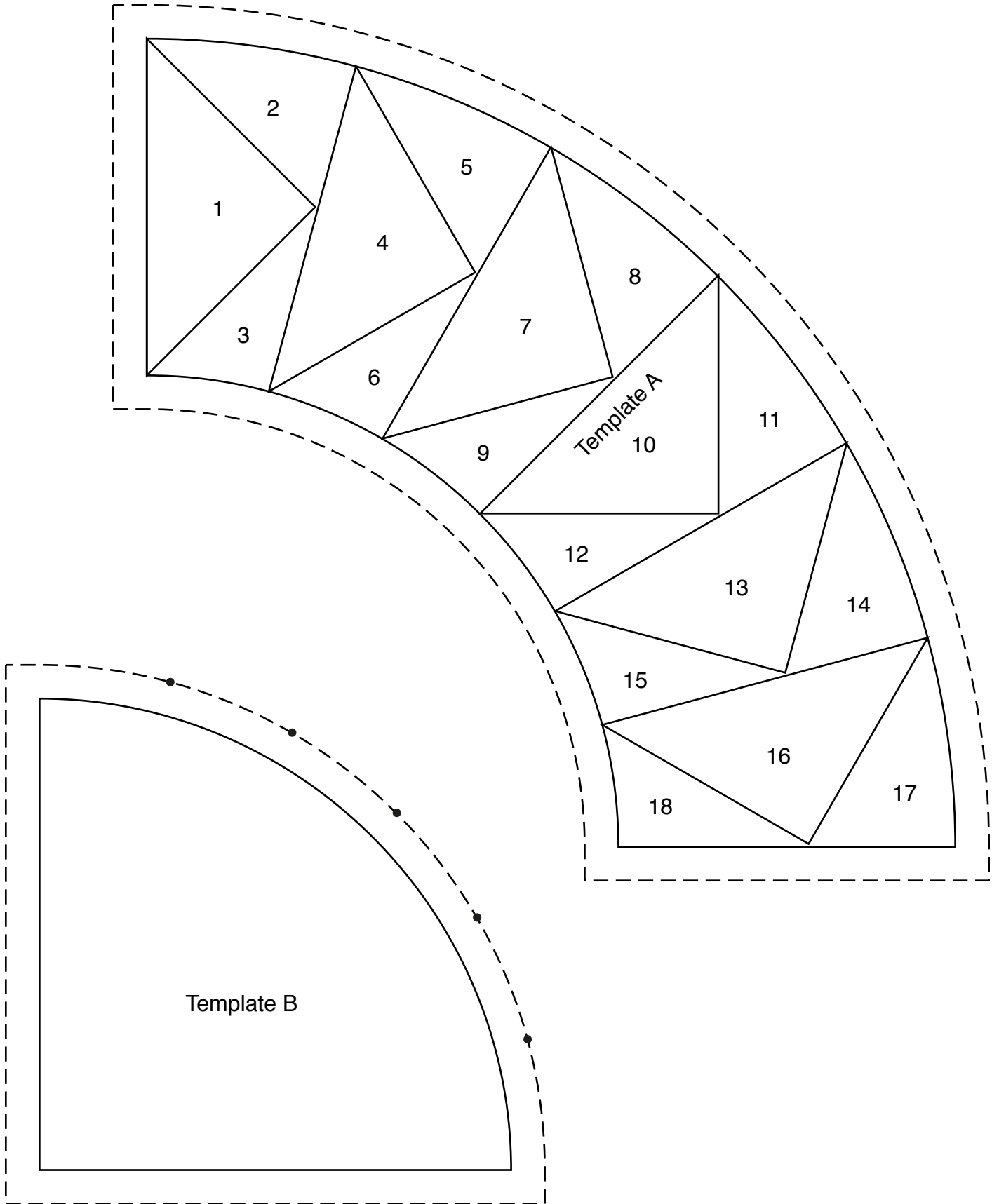

Block 5

EXPLODING STAR

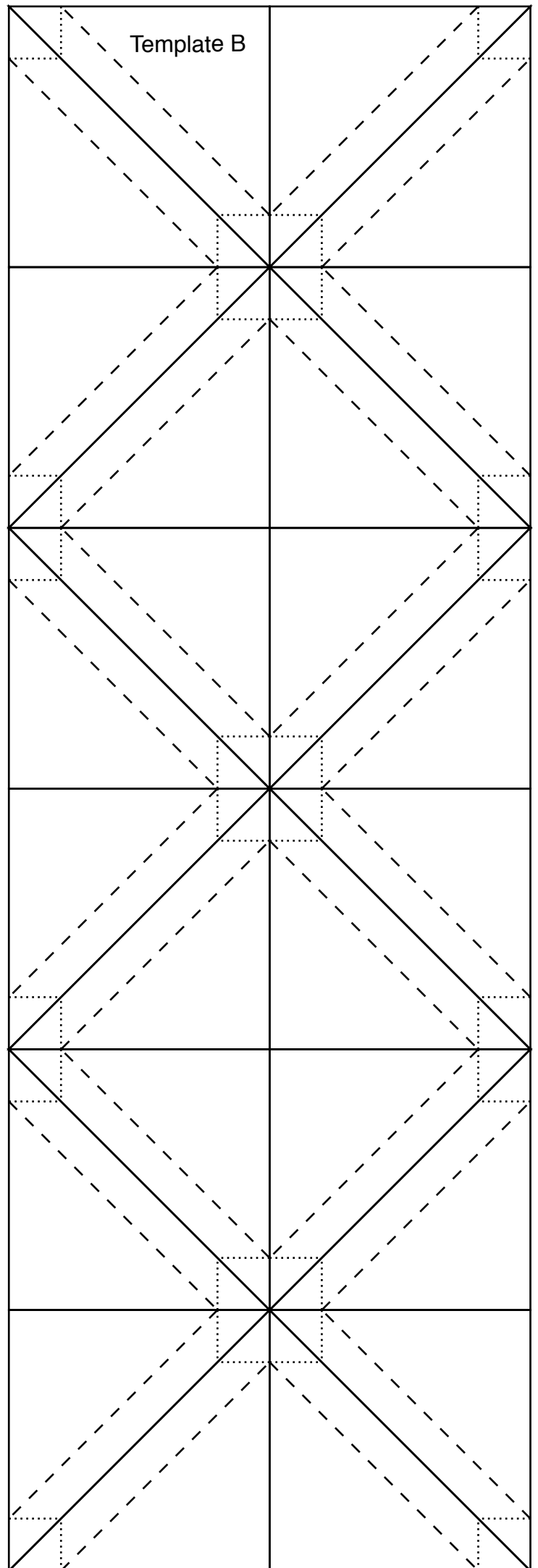
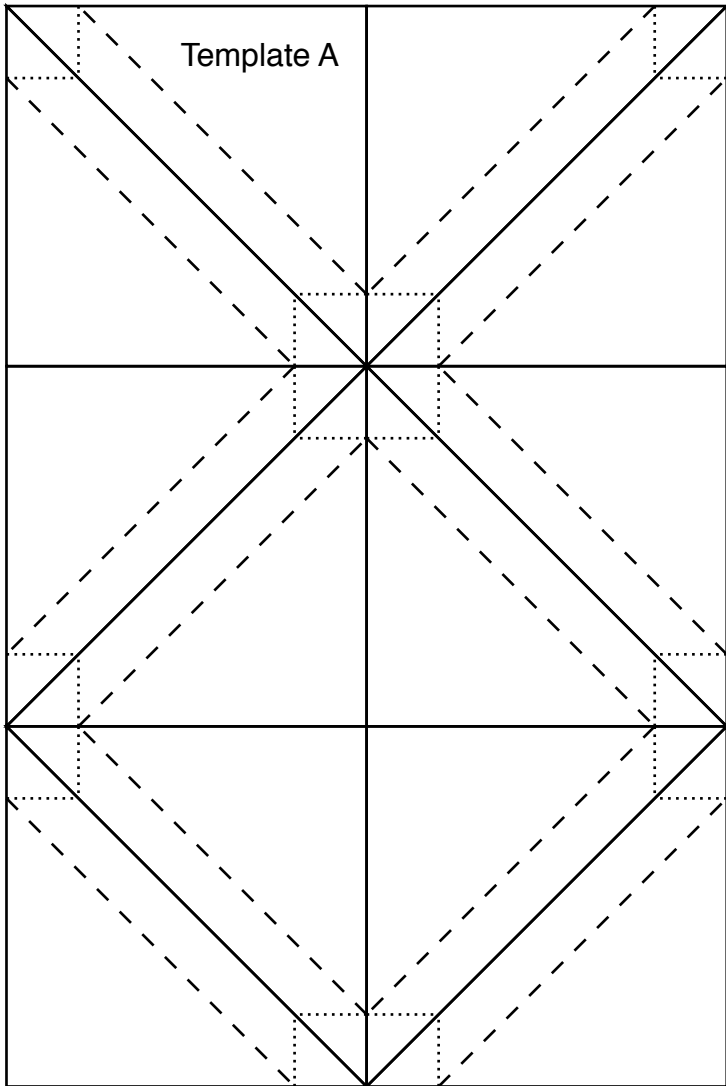

Block 5 EXPLODING STAR

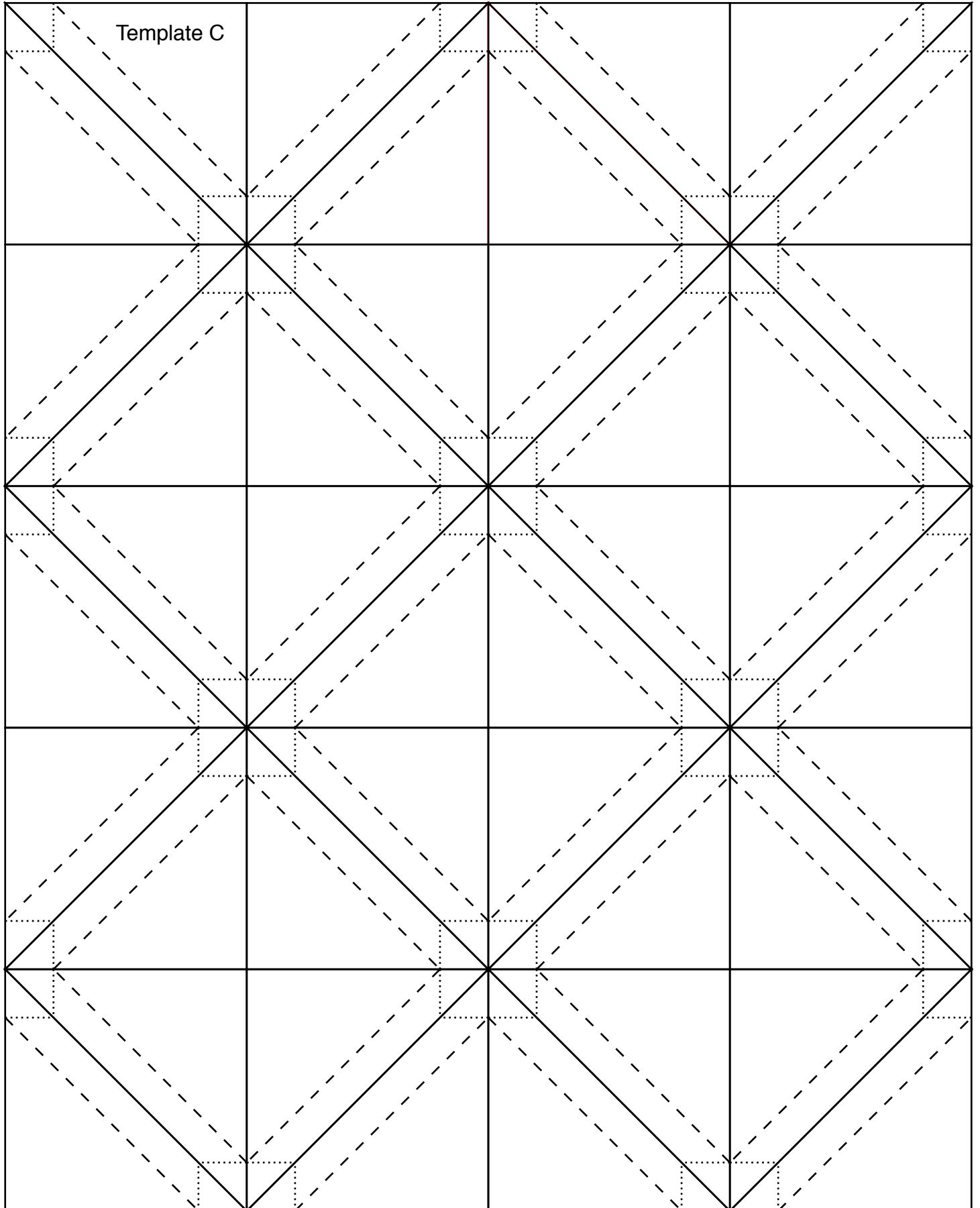

Block 6 CHECKERBOARD DRESDEN

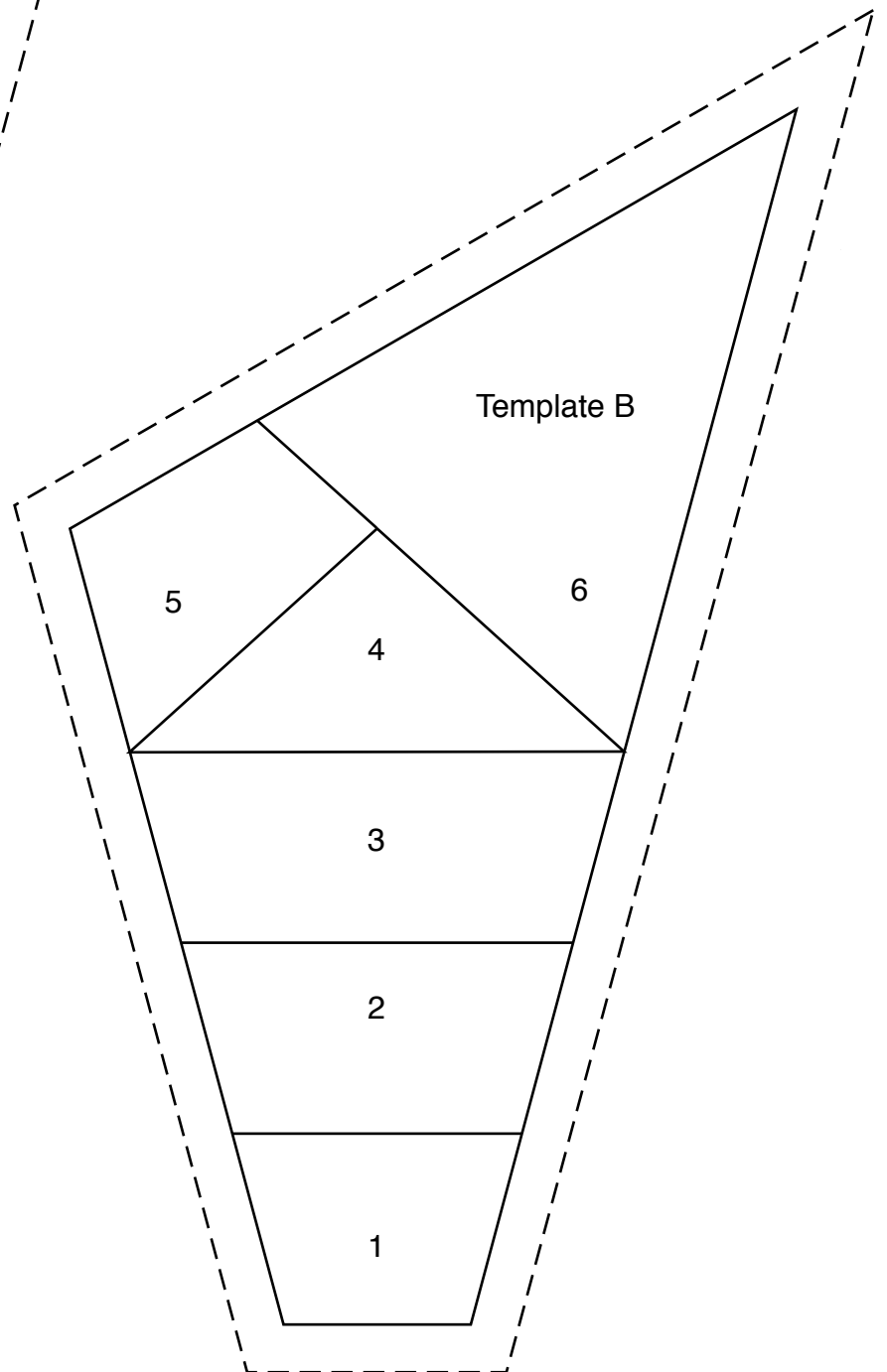
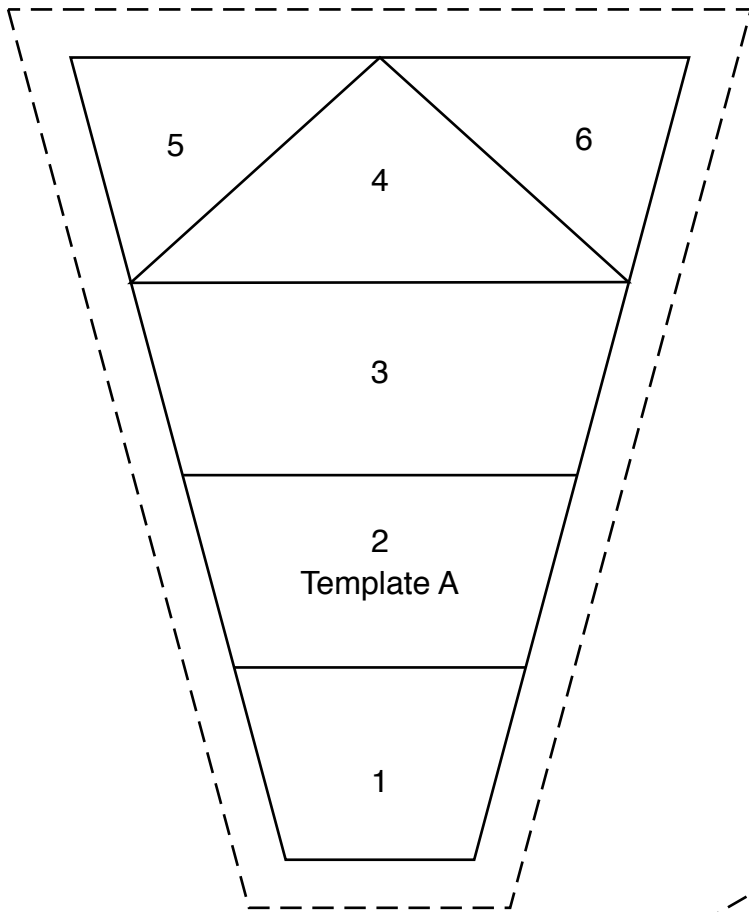

Block 6 CHECKERBOARD DRESDEN

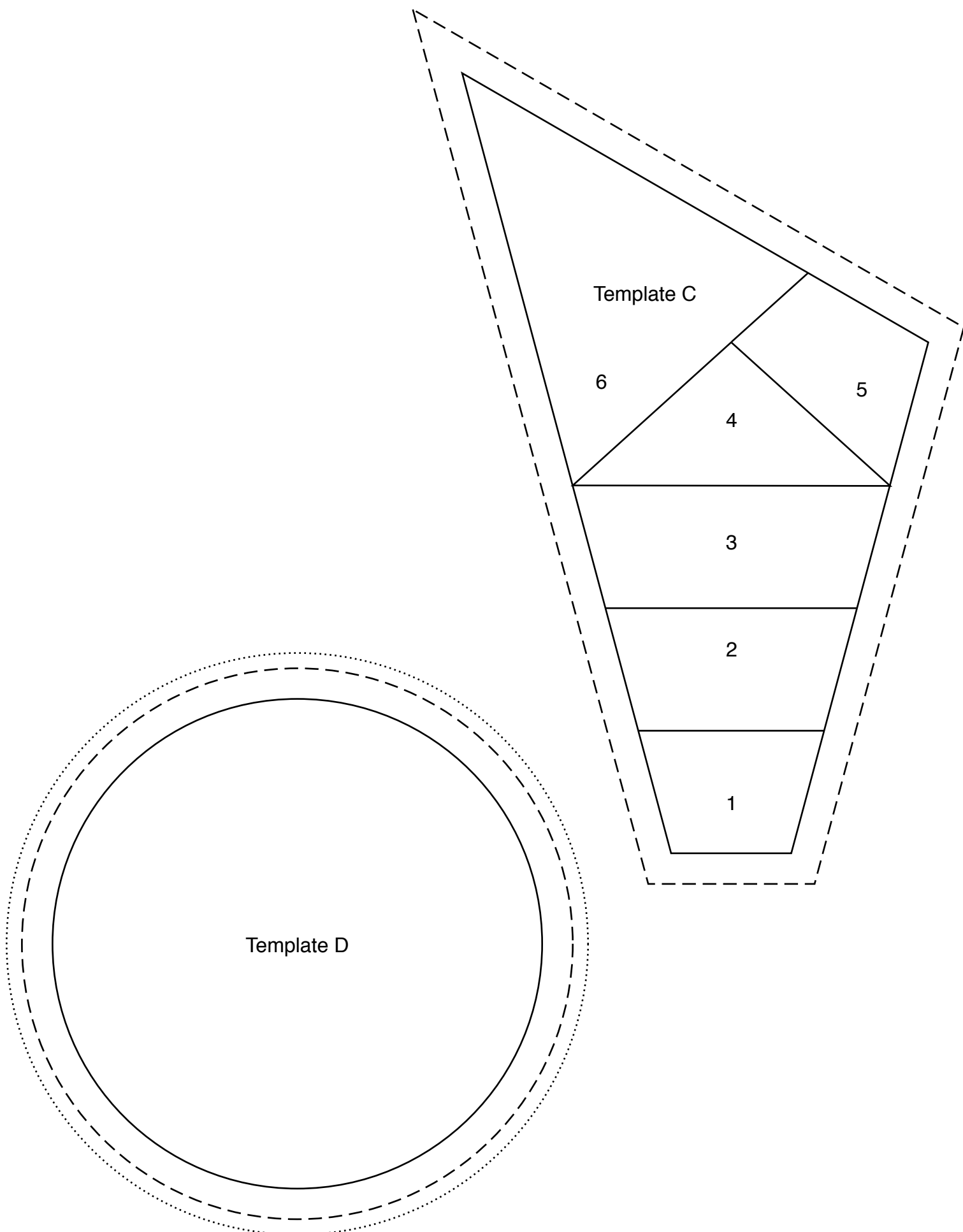

Block 7 HARLEQUIN STAR

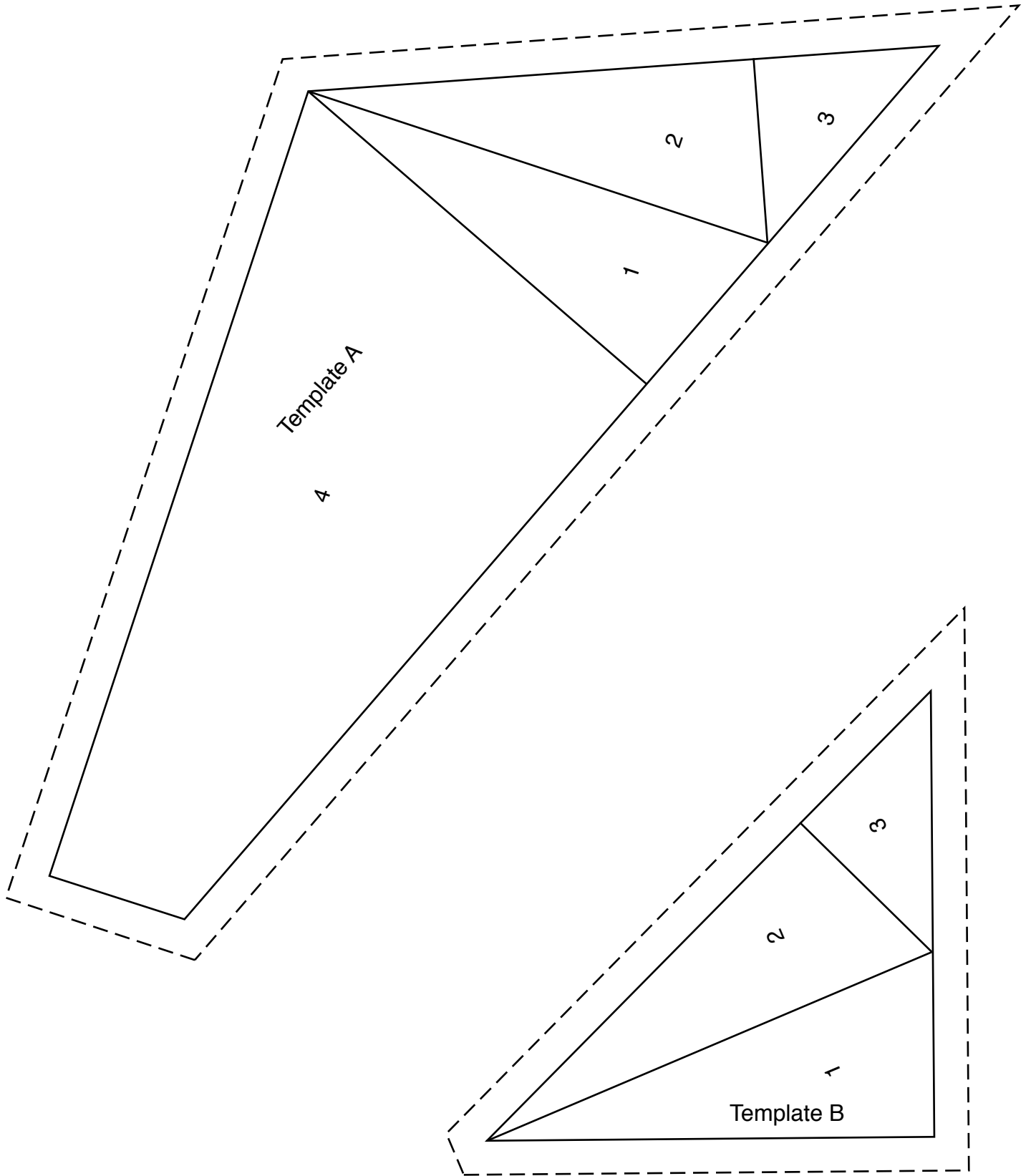

Block 7 HARLEQUIN STAR

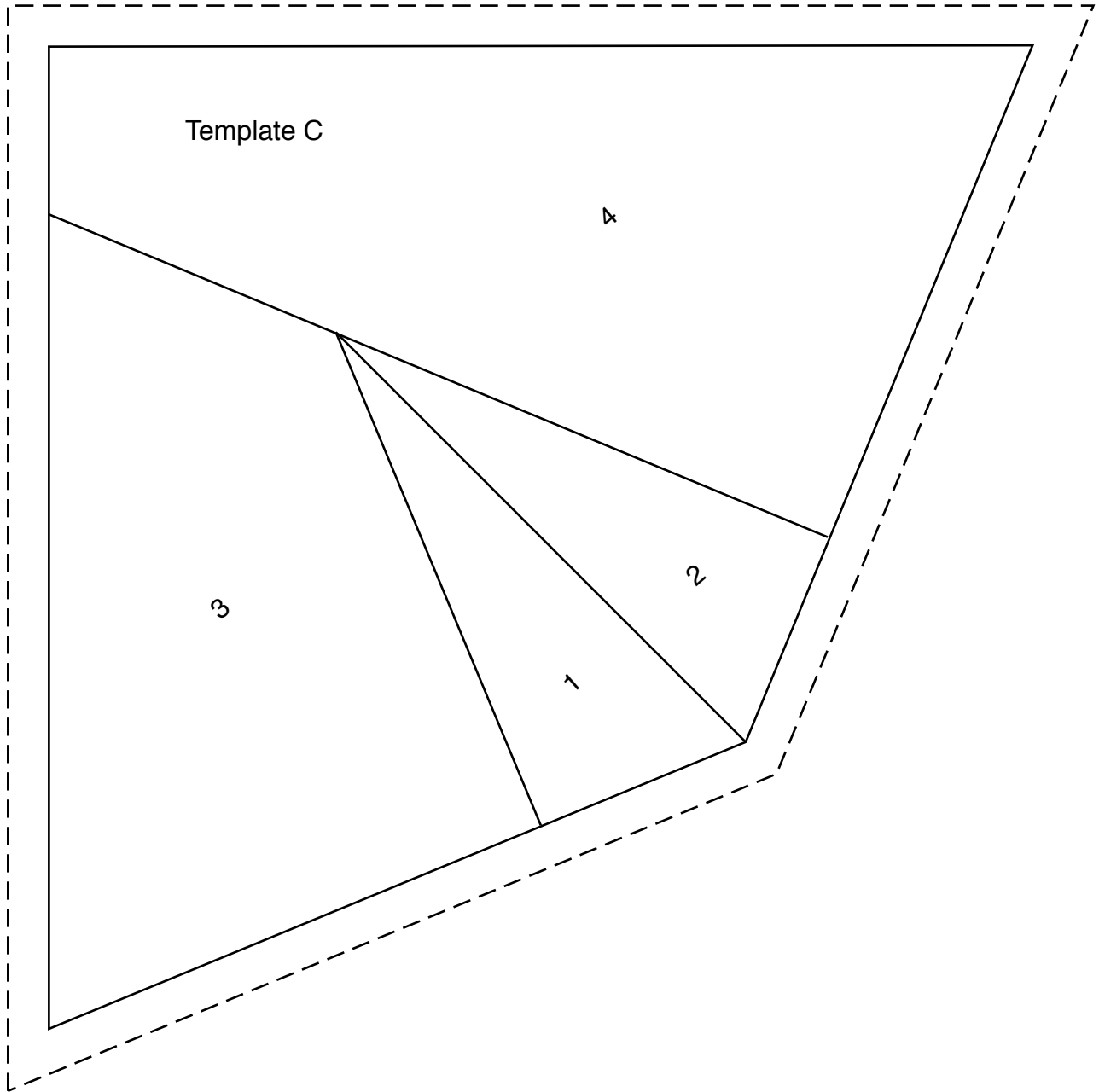

Thank you for making this project from *Today's Quilter*. The copyright for these templates belongs to the designer of the project. They work hard to create projects for you to enjoy, so please don't re-sell or distribute without permission. Please do not make any part of the templates or instructions available to others through your website or a third party website, or copy it multiple times without permission. Copyright law protects creative work and unauthorised copying is illegal. We appreciate your help.

Block 7 HARLEQUIN STAR

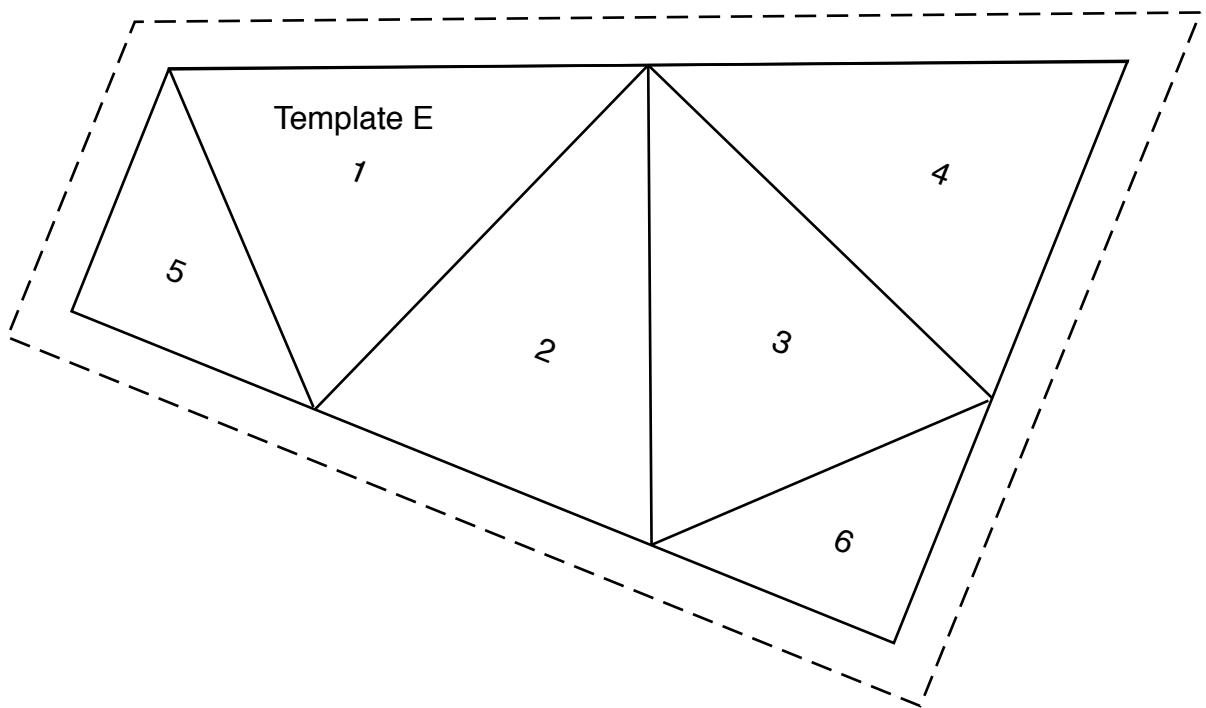
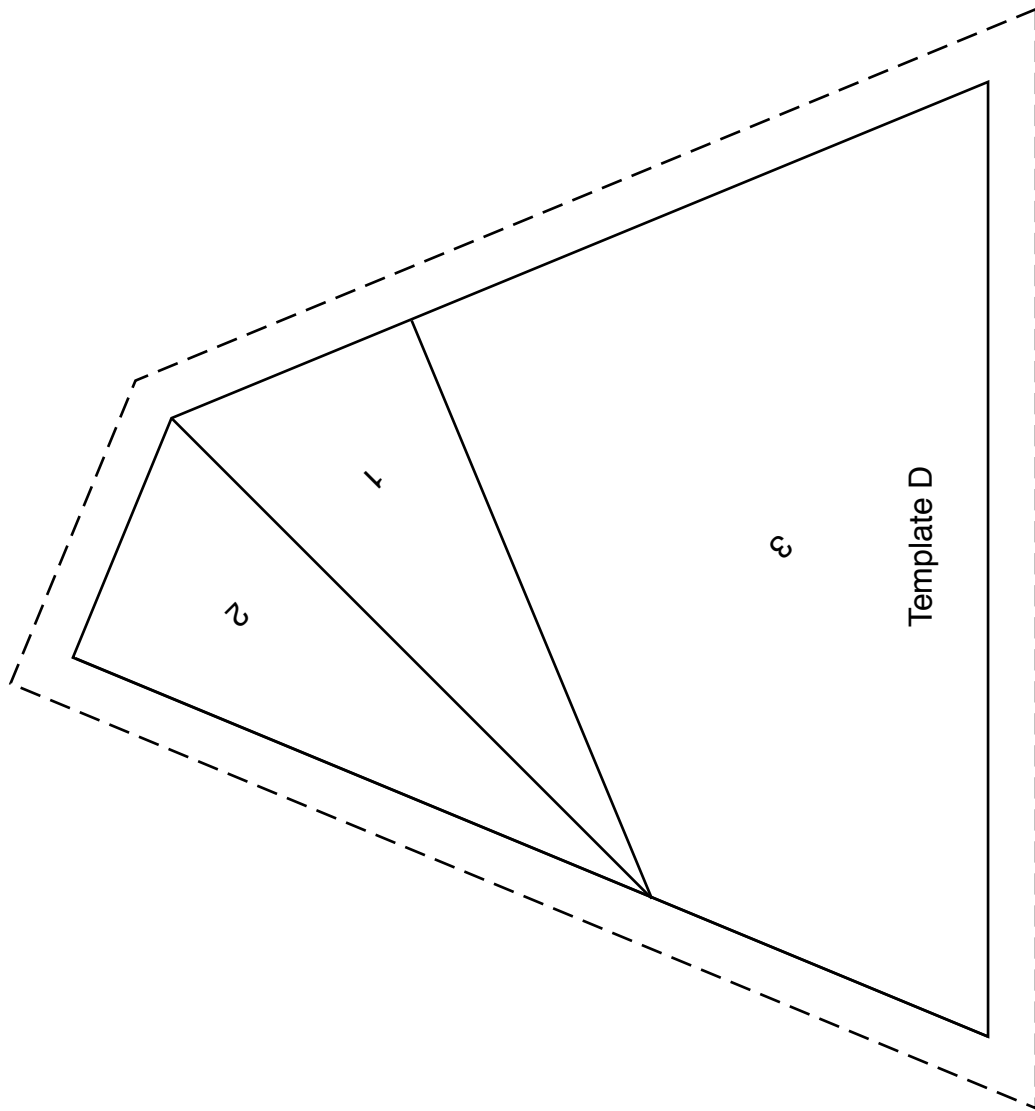

Block 8 MARINER'S COMPASS

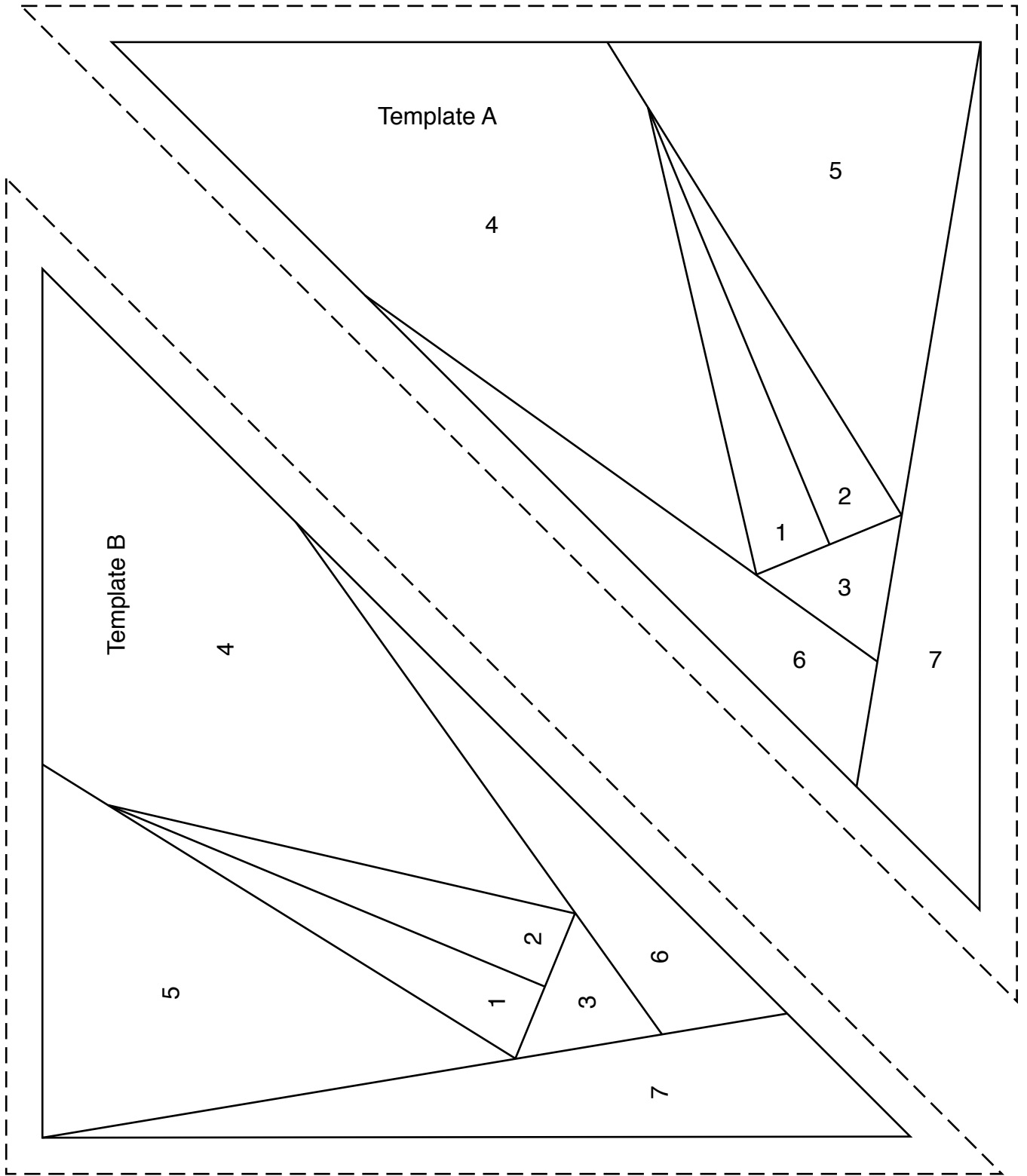

TRY 3 ISSUES FOR £5* WHEN YOU SUBSCRIBE TODAY!

THE NO. 1 QUILTING MAGAZINE WITH GORGEOUS PROJECTS & EXPERT ADVICE

TODAY'S QUILTER JO AVERY makes the most of her time inside the house
ISSUE 62
Create beautiful quilts for your home

HEART OF THE HOME
Sew this beautiful Log Cabin quilt and matching cushion

THE ESSENTIAL GUIDE
MACHINE BLANKET STITCH
Use your machine for quick results
BY LINDA CLEMENTS

Hand stitched!
WHILE AWAY TIME WITH A PRETTY APPLIQUE OVEN SET

PIECED PERFECTION
MAKE A STUNNING MILLEFIORI QUILT

BRIGHT & BOLD
SHOW OFF YOUR FAVOURITE FABRICS IN THIS DESIGN

THE ESSENTIAL GUIDE
EQUILATERAL TRIANGLES
Cut & sew these versatile shapes
BY LINDA CLEMENTS

THE ESSENTIAL GUIDE
SEMINOLE PATCHWORK
Create distinctive geometric forms
BY LINDA CLEMENTS

Fresh for you!
Fabulous Flying Geese project, plus Jen Jones & her daughter chat about their shared love of antique quilts

New for you!
Meet Millefiori quilt designer Willyne Hammerstein & explore the world of quilt and textile resources online

Fabrics for your stash

Lin Clements

TODAY'S QUILTER – your favourite magazine with a fresh take on traditional quilting

—★—
PROJECTS by stars of the quilt world

—★—
BEAUTIFUL PHOTOGRAPHY that showcases stunning quilt creations

Subscribe online, it's quick and easy!

Visit www.buysubscriptions.com/TQGTHA

or call 03330 162 154[†] QUOTE CODE TQGTHA

Lines are open 8am-6pm weekdays and 9am-1pm Saturday (orders only on Saturday)

*This introductory offer is for new UK Direct Debit subscribers only and ends 31st December 2021. You will receive your first 3 issues for £5 and then save 18% on the shop price with a Direct Debit step up of £29.49 every 6 issues. If you cancel within 2 weeks of your penultimate issue you will pay no more than the £5 shown. All prices include home delivery. Full details of the Direct Debit guarantee are available on request. Prices correct at point of print and subject to change. We reserve the right to reject or cancel any application for a trial subscription offer if you have you have previously benefitted from a trial offer for the same magazine in the last 12 months or had three or more trial subscriptions to any magazine in the Immediate Media portfolio. †UK calls will cost the same as other standard fixed line numbers (starting 01 or 02) and are included as part of any inclusive or free minutes allowances (if offered by your phone tariff). Outside of free call packages call charges from mobile phones will cost between 3p and 55p per minute.