



Templates

Issue 49

PRINT AT 100% SIZE

When printed
at the correct
size, this box
will measure
1in / 26mm
square

HEDGEROW ADVENTURES

Fi Bowman page 62

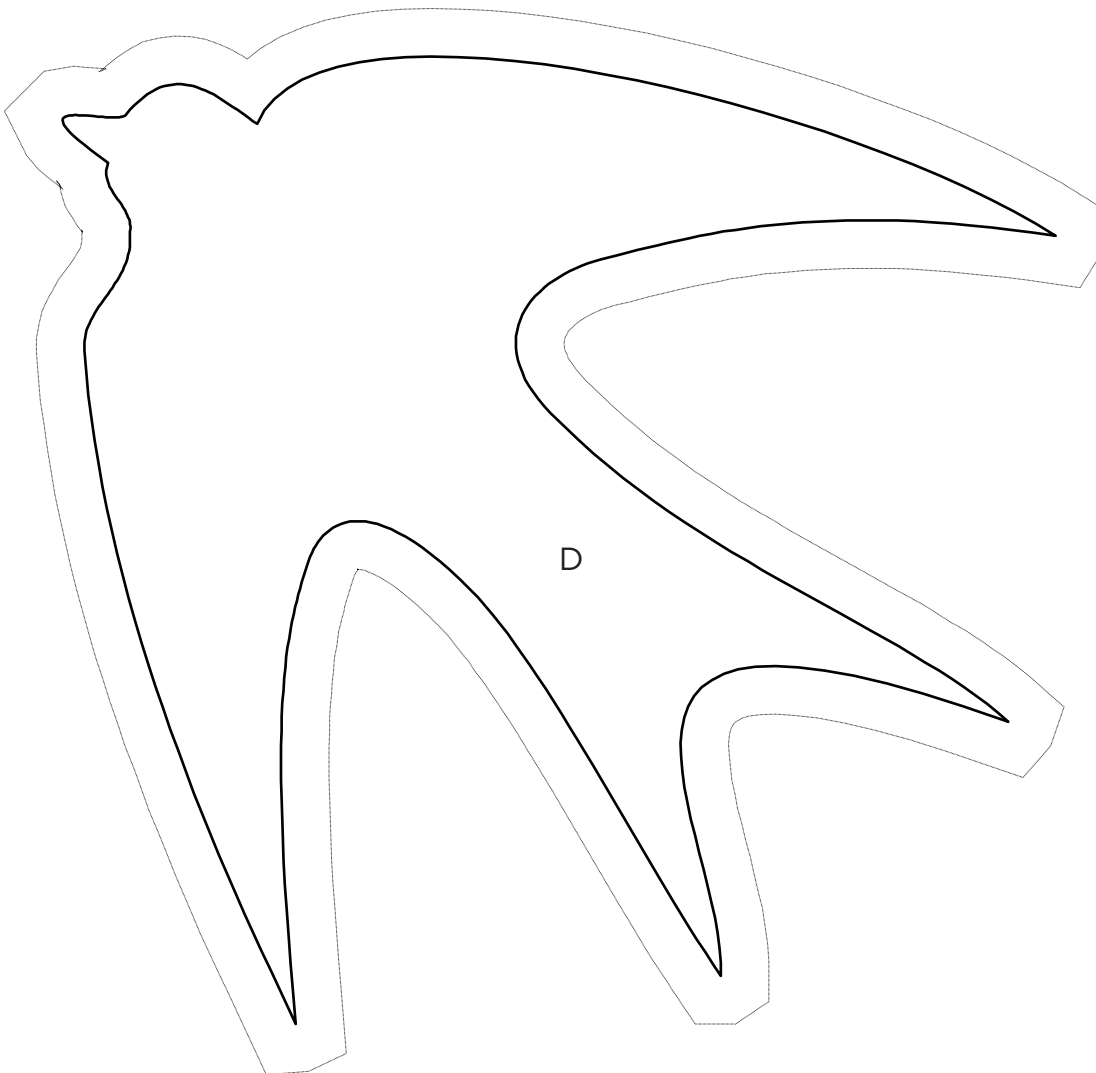
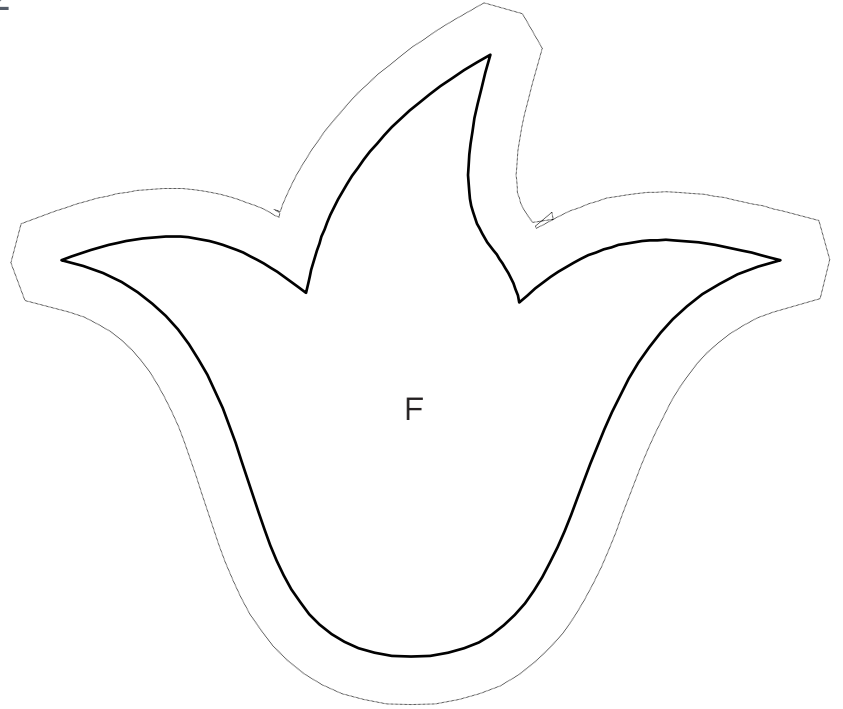

When printed
at the correct
size, this box
will measure
1in / 26mm
square

HEDGEROW ADVENTURES

Fi Bowman page 62

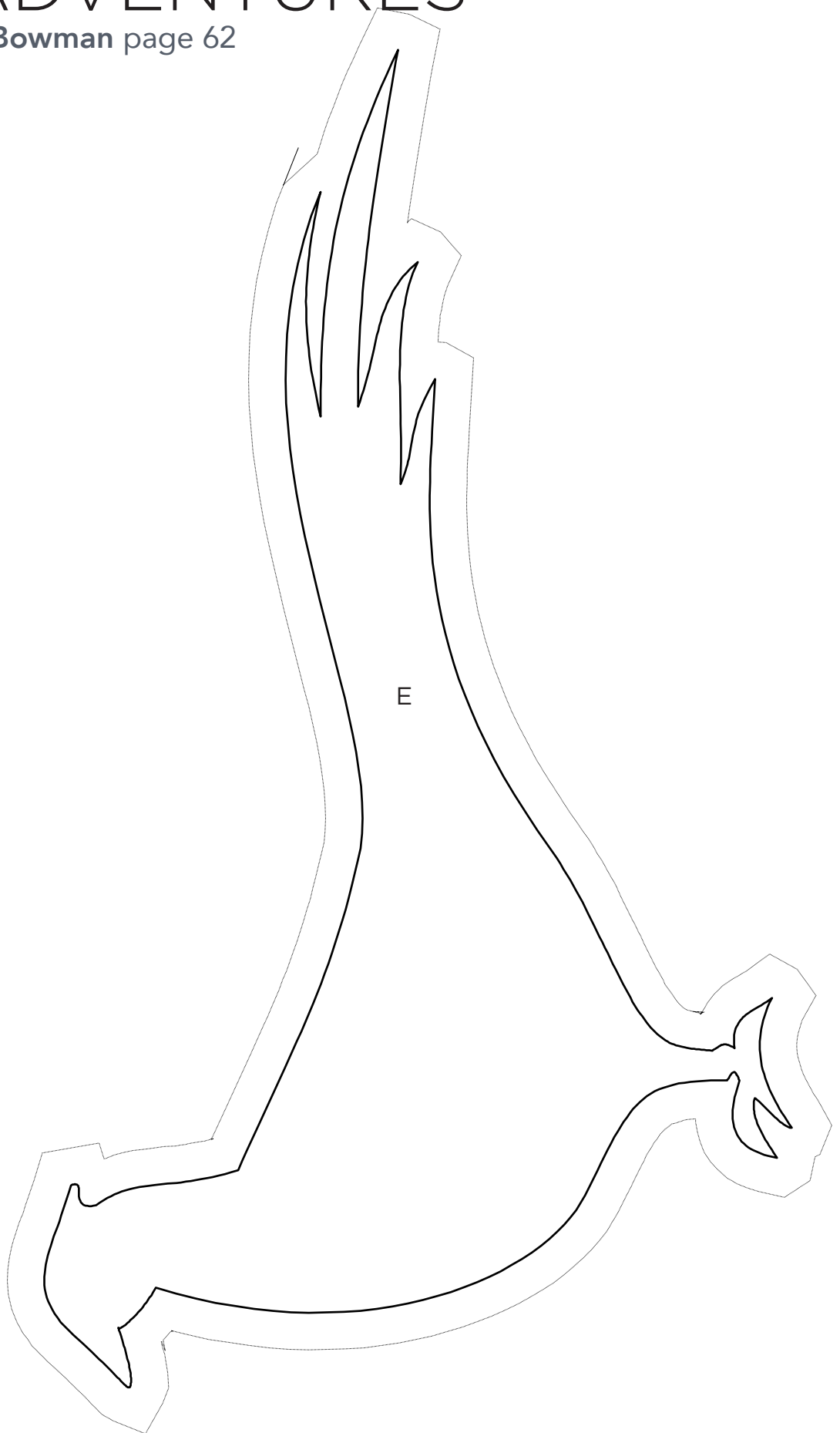

When printed
at the correct
size, this box
will measure
1in / 26mm
square

HEDGEROW ADVENTURES

Fi Bowman page 62

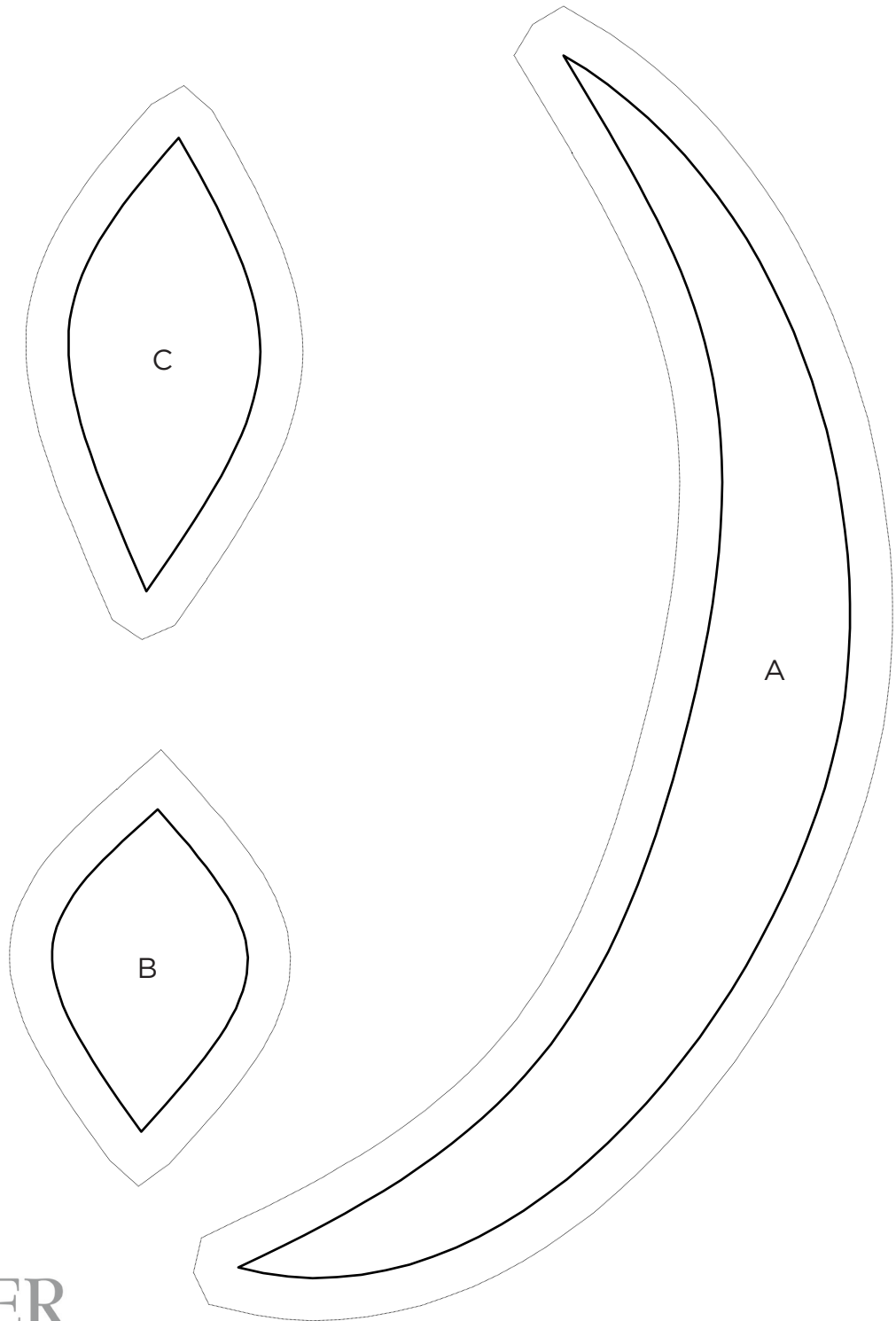

TODAY'S
QUILTER
Create beautiful quilts for your home

Thank you for making this project from Today's Quilter. The copyright for these templates belongs to the designer of the project. Please don't re-sell or distribute their work without permission. Please do not make any part of the templates or instructions available to others through your website or a third party website, or copy it multiple times without our permission. Copyright law protects creative work and unauthorised copying is illegal. We appreciate your help.

When printed
at the correct
size, this box
will measure
1in / 26mm
square

BLOCK OF THE MONTH

Carolyn Forster page 83

PLEASE NOTE: Hand-piecing templates do not include seam allowances

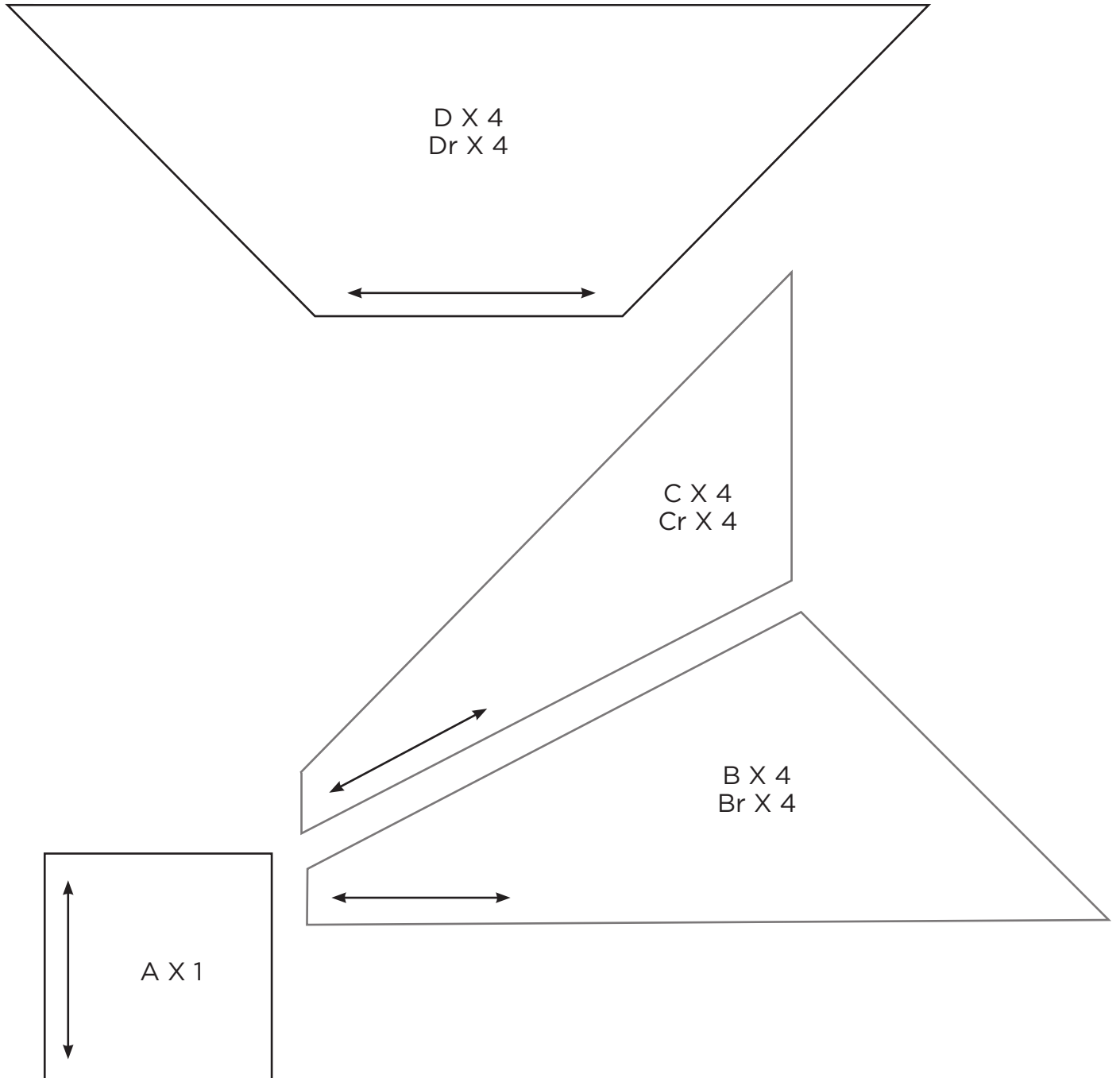

When printed
at the correct
size, this box
will measure
1in / 26mm
square

BLOCK OF THE MONTH

Carolyn Forster page 83

Unit B

Block 1

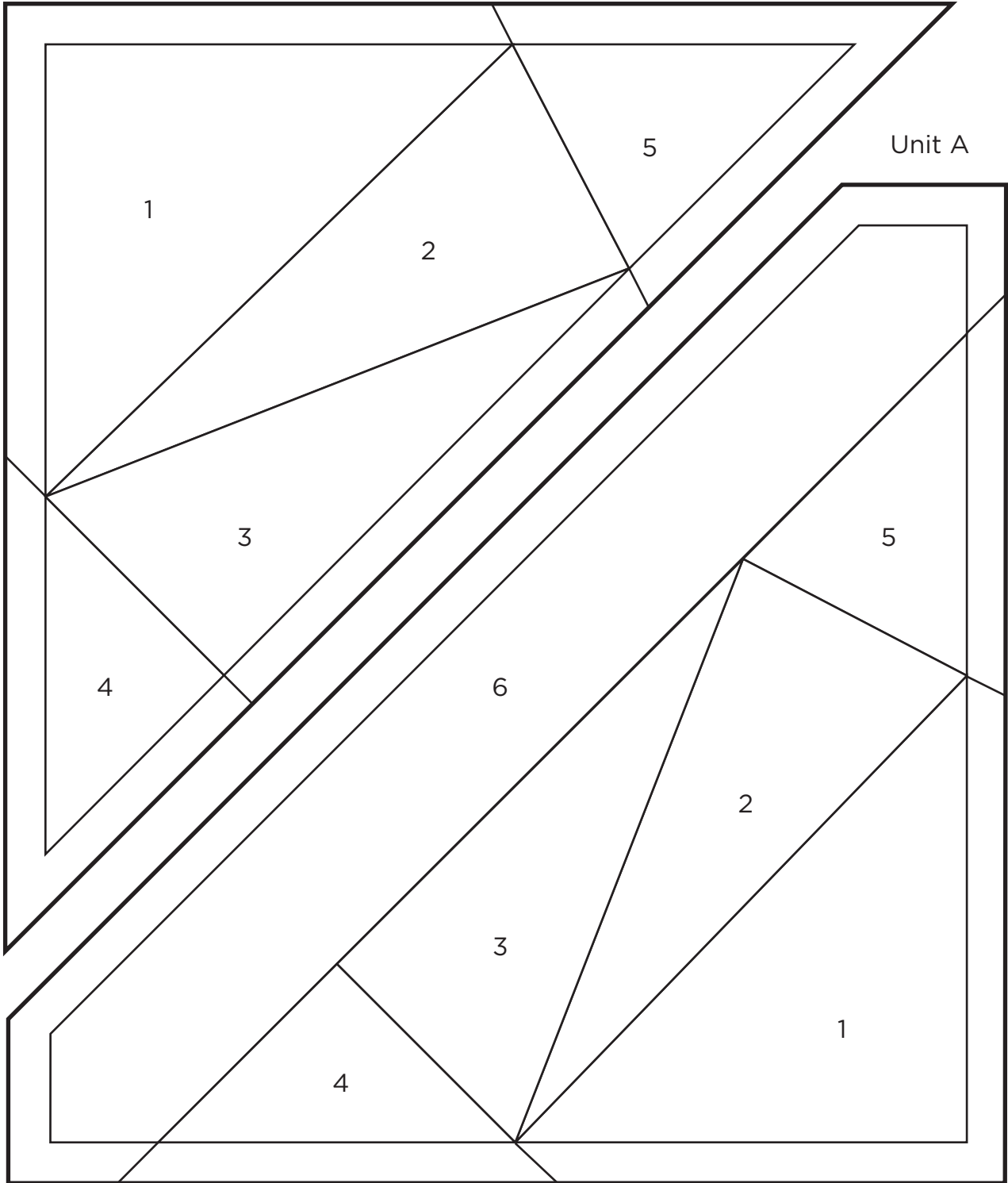

When printed
at the correct
size, this box
will measure
1in / 26mm
square

SUMMER GARDEN

Linda Clements page 22

Block 2

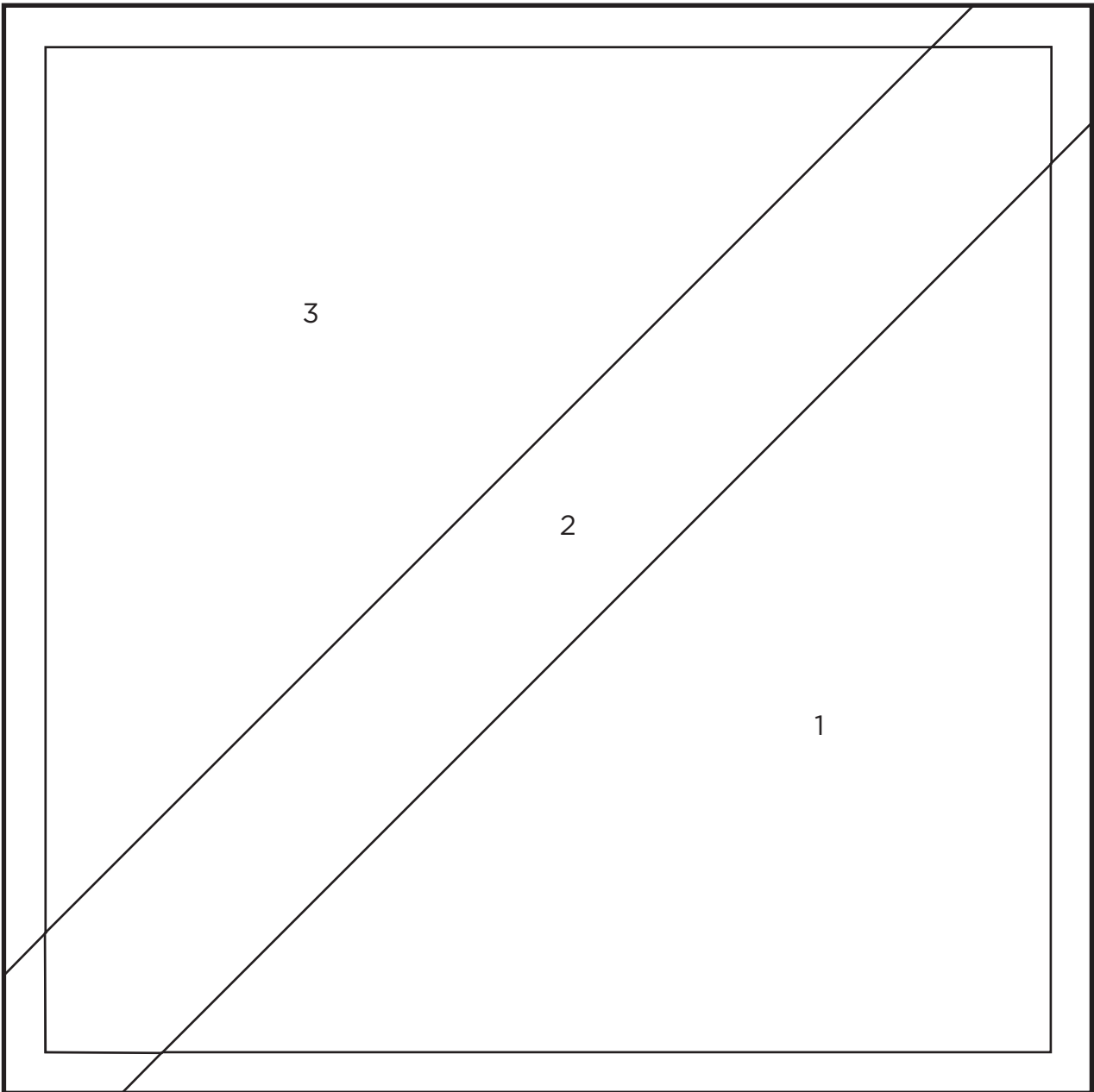

When printed at the correct size, this box will measure 1in / 26mm square

MOONLIT CHERRY BLOSSOM

Angela Attwood page 38

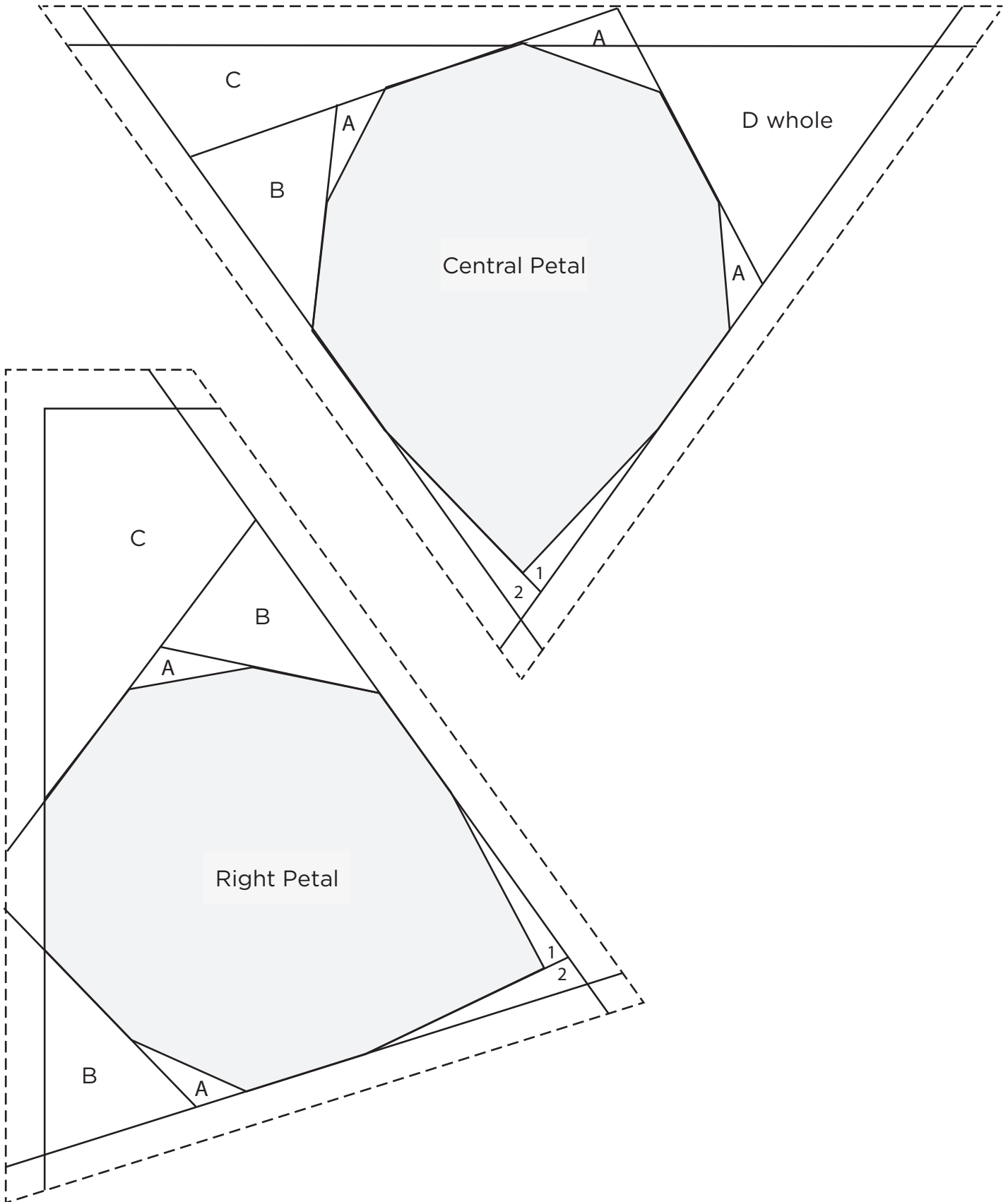

When printed
at the correct
size, this box
will measure
1in / 26mm
square

MOONLIT CHERRY BLOSSOM

Angela Attwood page 38

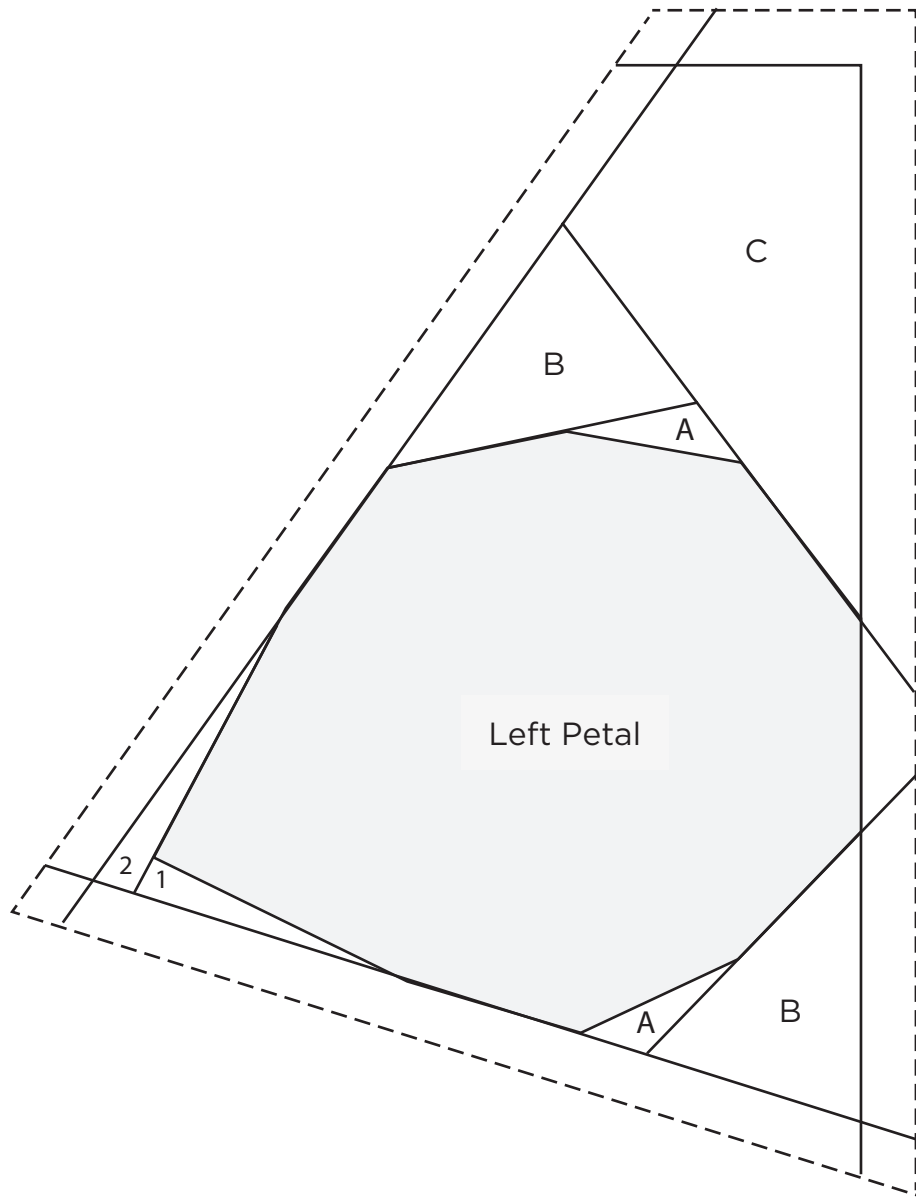

When printed
at the correct
size, this box
will measure
1in / 26mm
square

MOONLIT CHERRY BLOSSOM

Angela Attwood page 38

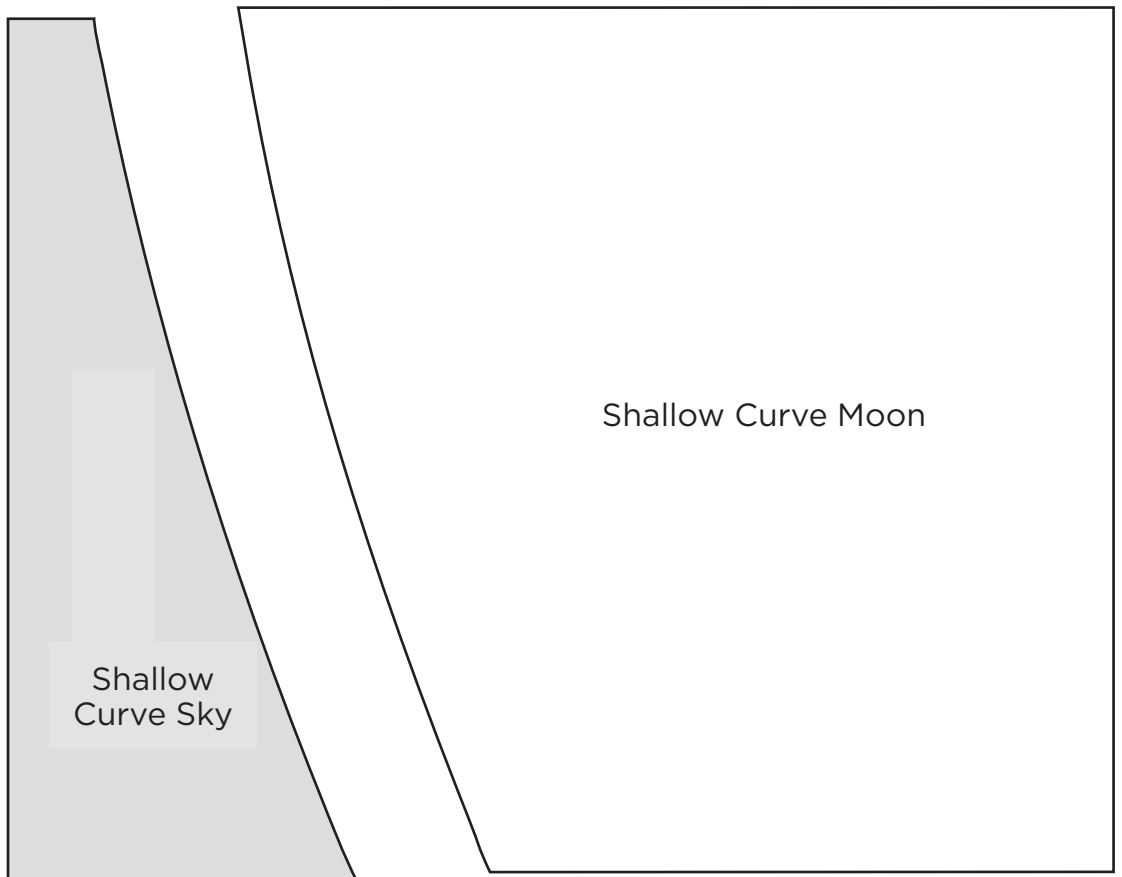
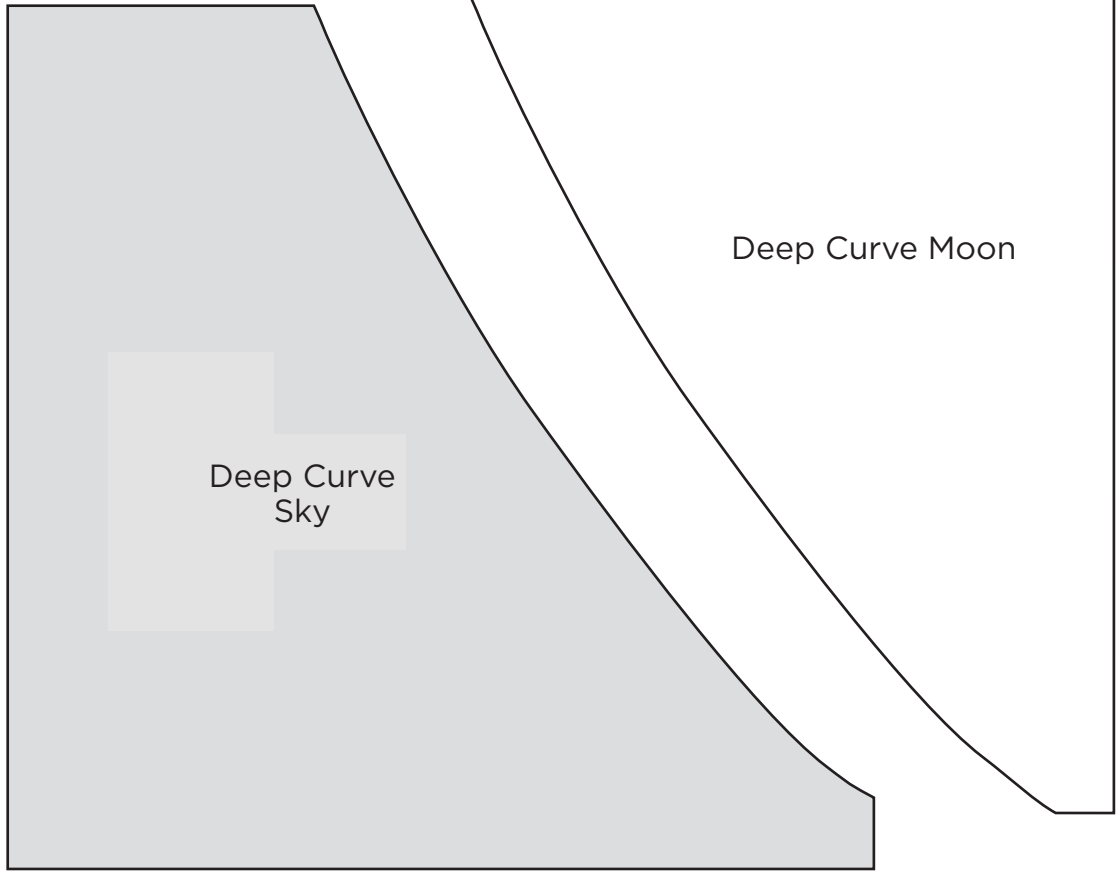

TODAY'S
QUILTER
Create beautiful quilts for your home

Thank you for making this project from Today's Quilter. The copyright for these templates belongs to the designer of the project. Please don't re-sell or distribute their work without permission. Please do not make any part of the templates or instructions available to others through your website or a third party website, or copy it multiple times without our permission. Copyright law protects creative work and unauthorised copying is illegal. We appreciate your help.

When printed
at the correct
size, this box
will measure
1in / 26mm
square

MOONLIT CHERRY BLOSSOM

Angela Attwood page 38

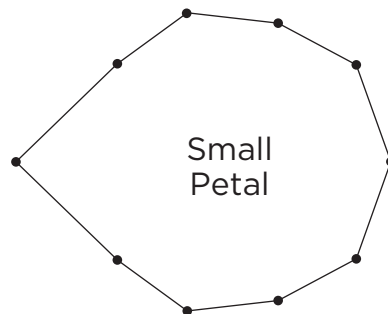
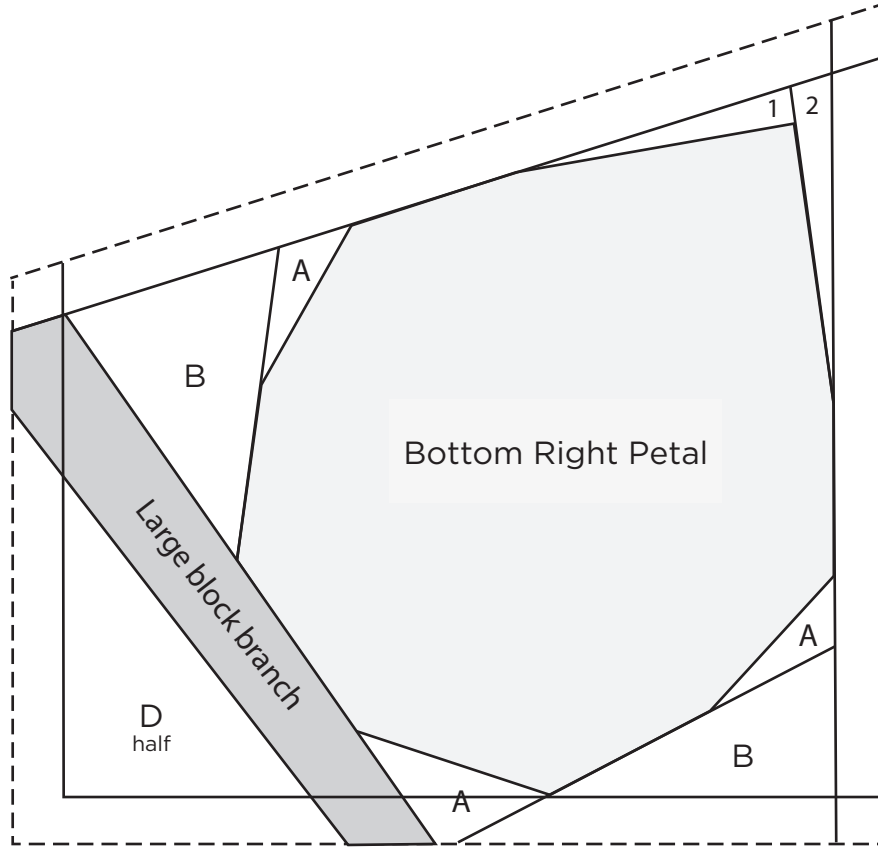

When printed at the correct size, this box will measure 1in / 26mm square

MOONLIT CHERRY BLOSSOM

Angela Attwood page 38

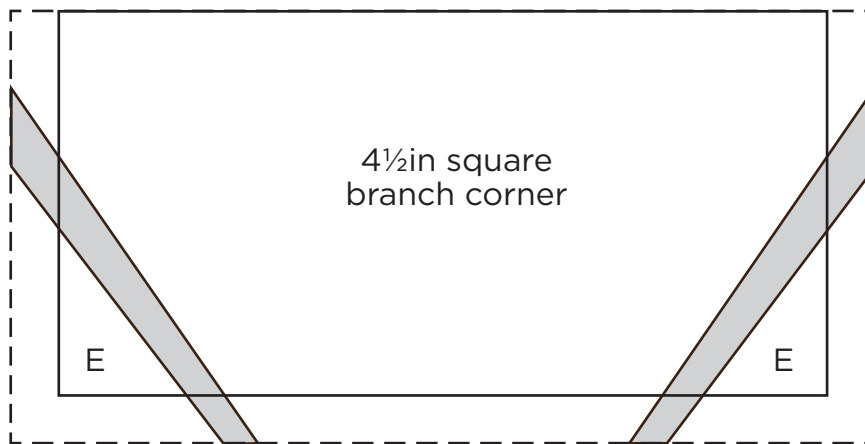
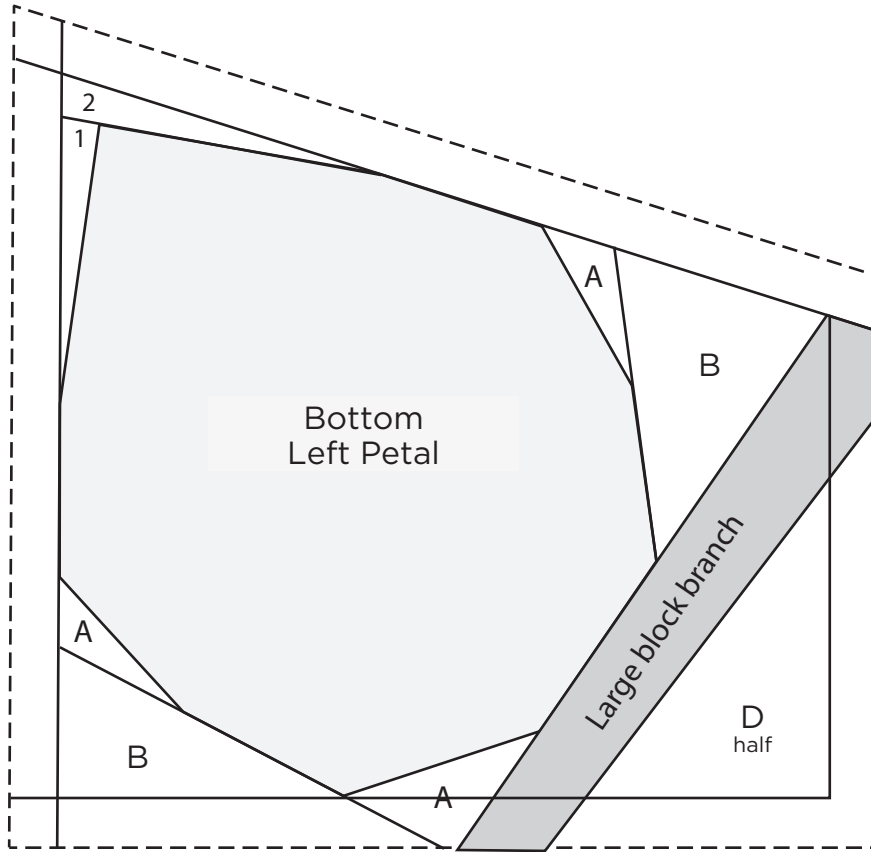

When printed
at the correct
size, this box
will measure
1in / 26mm
square

PIN CUSHION PATCHES

Carolyn Forster page 77

