

Your free *templates*



All the templates & outlines you'll need
for the projects in issue 194

Cut	——
Mountain fold	-----
Valley fold

Occasions –
tiger card
page 51,
use at 100%

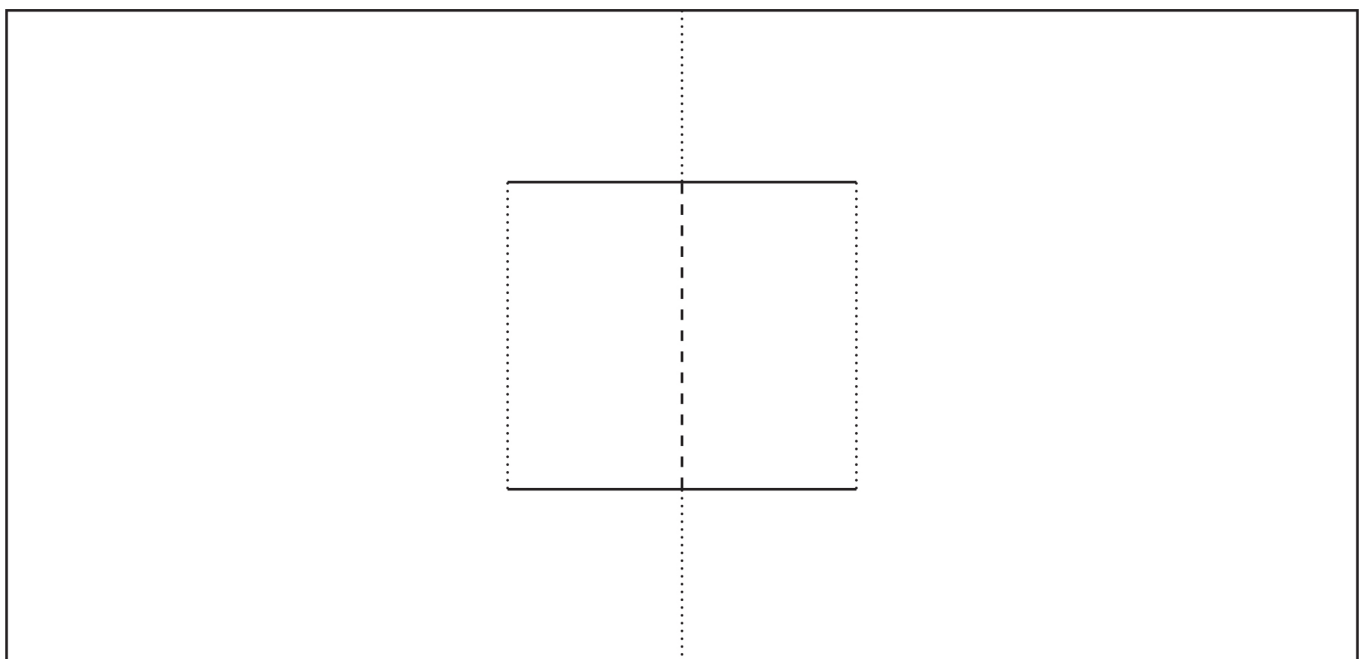
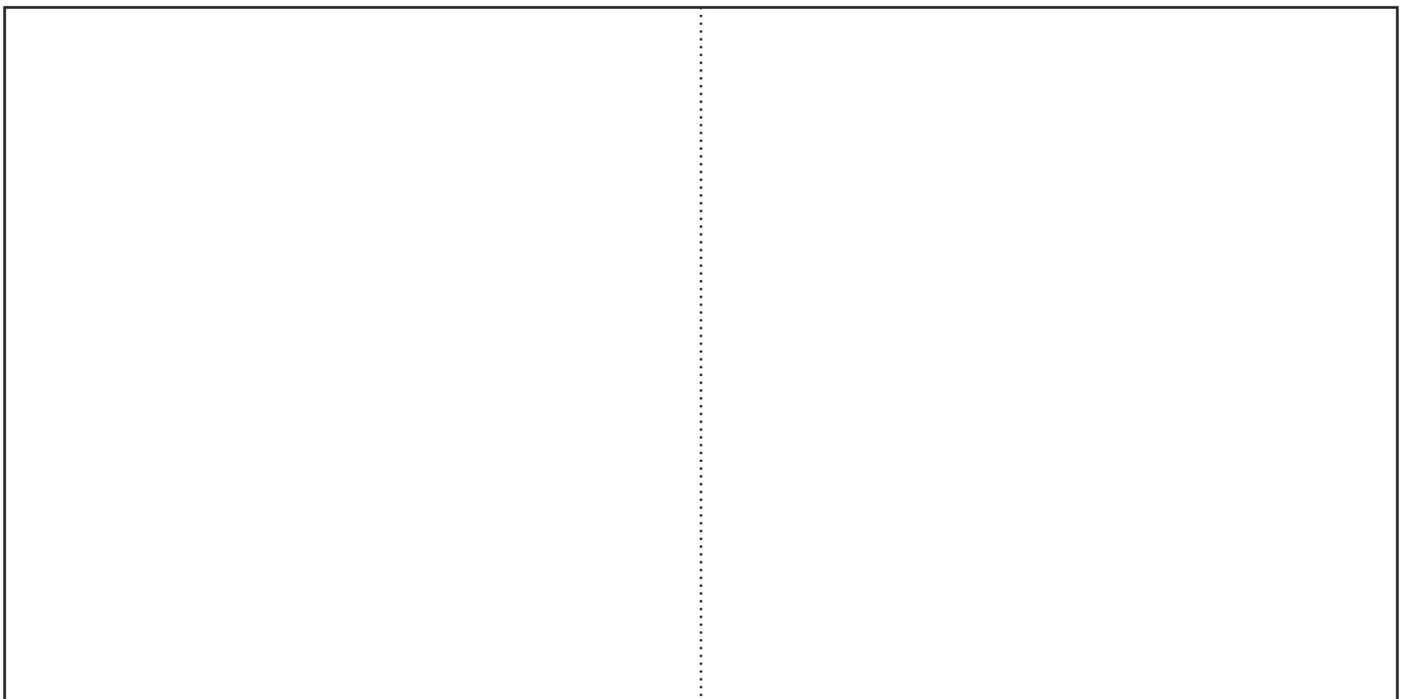
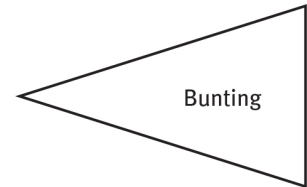

Cut _____
Fold - - - - -

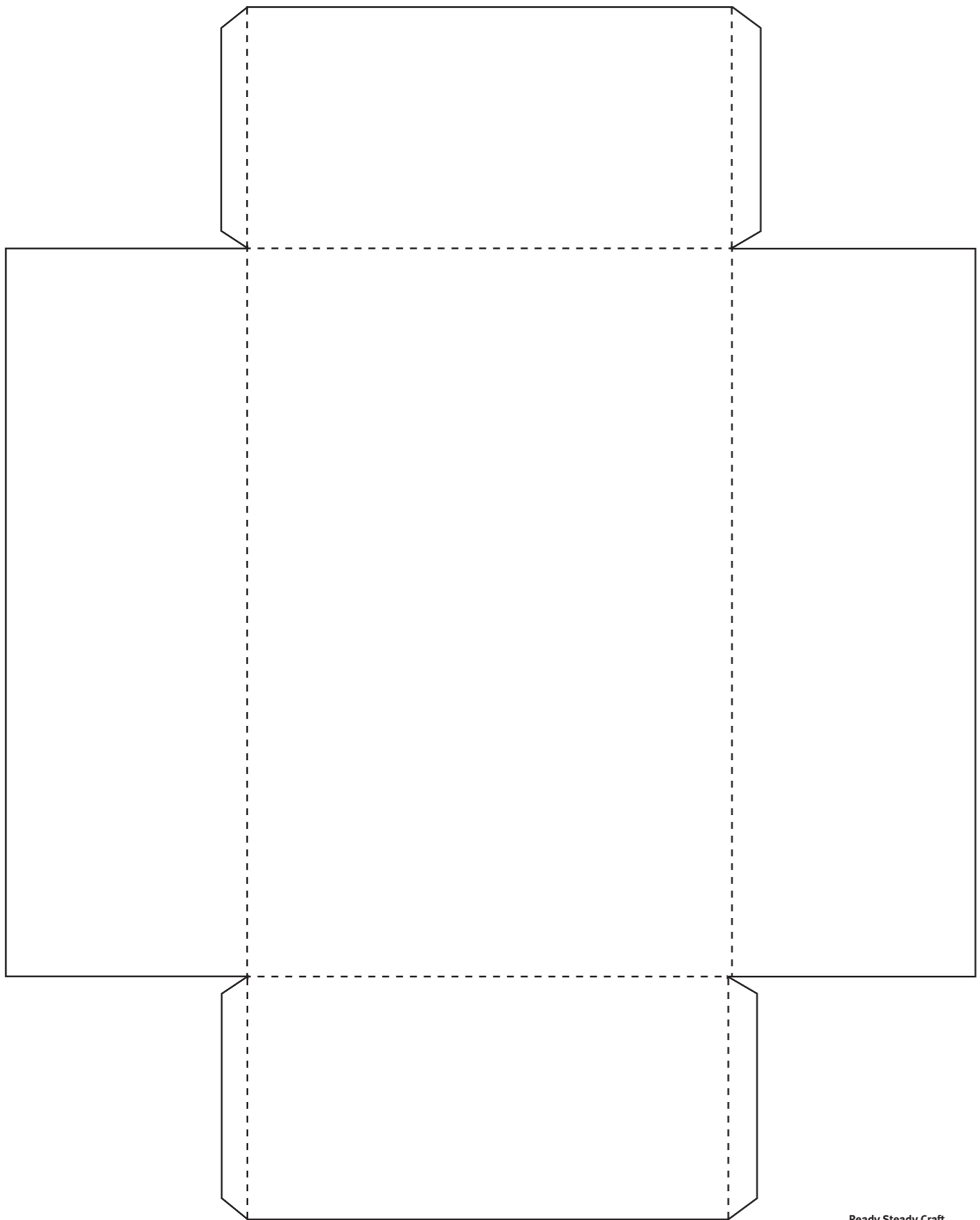

Ready Steady Craft
page 58,
use at 100%

Cut _____
Fold - - - - -

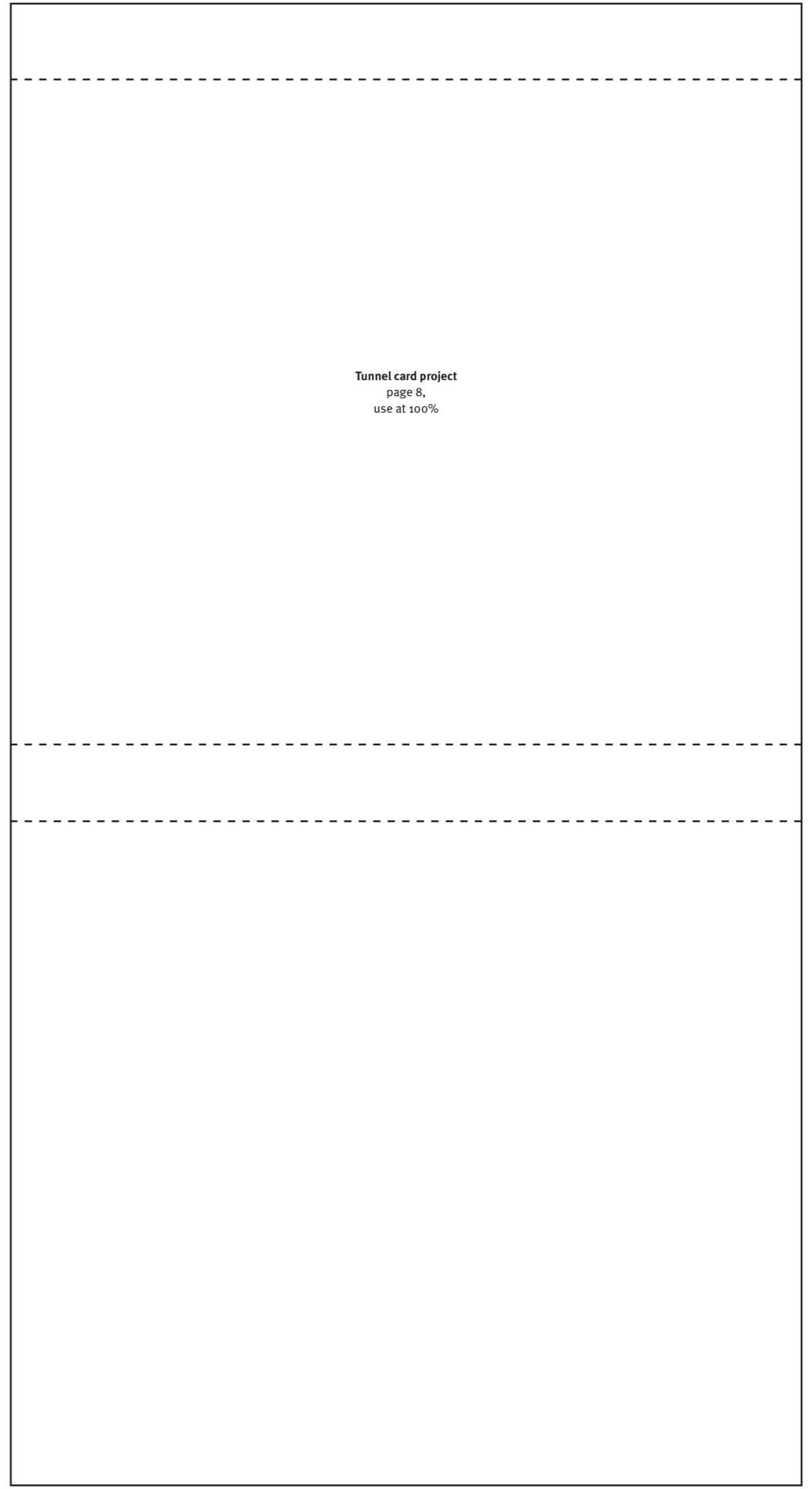

Tunnel card project
page 8,
use at 100%

Cut ———
Fold - - - - -

Tunnel card project
page 8,
use at 100%

Cut ———
Fold - - - - -

Tunnel card project
page 8,
use at 100%

0123456789

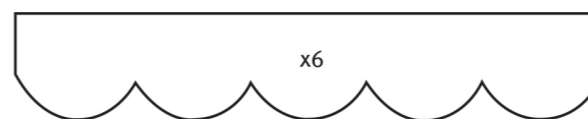

x6

Brother Scan N Cut – owl
page 16,
use at 100%

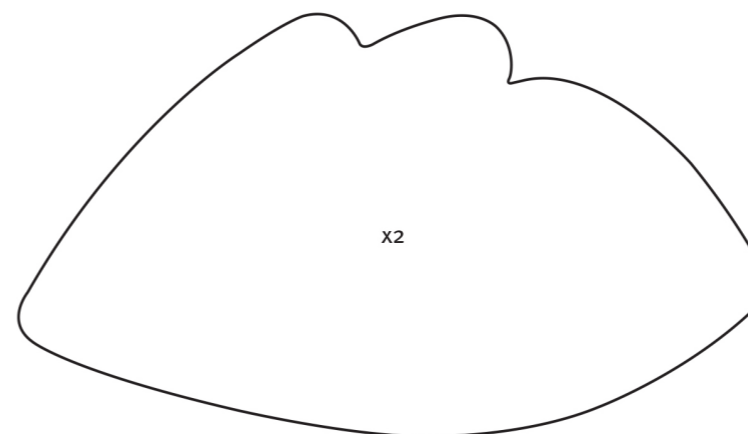

x2

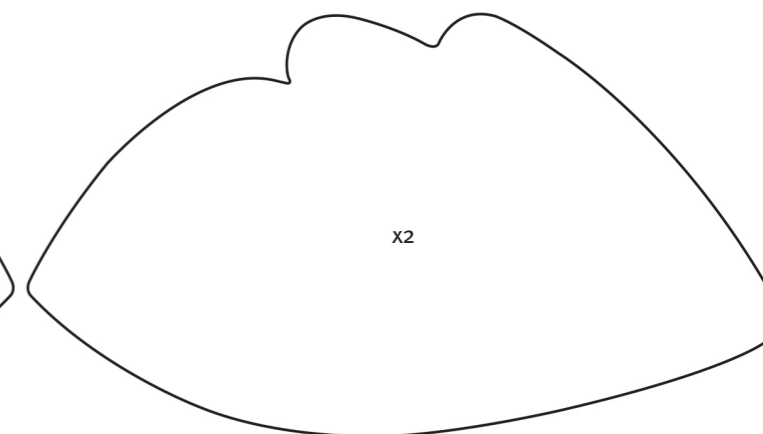

x2

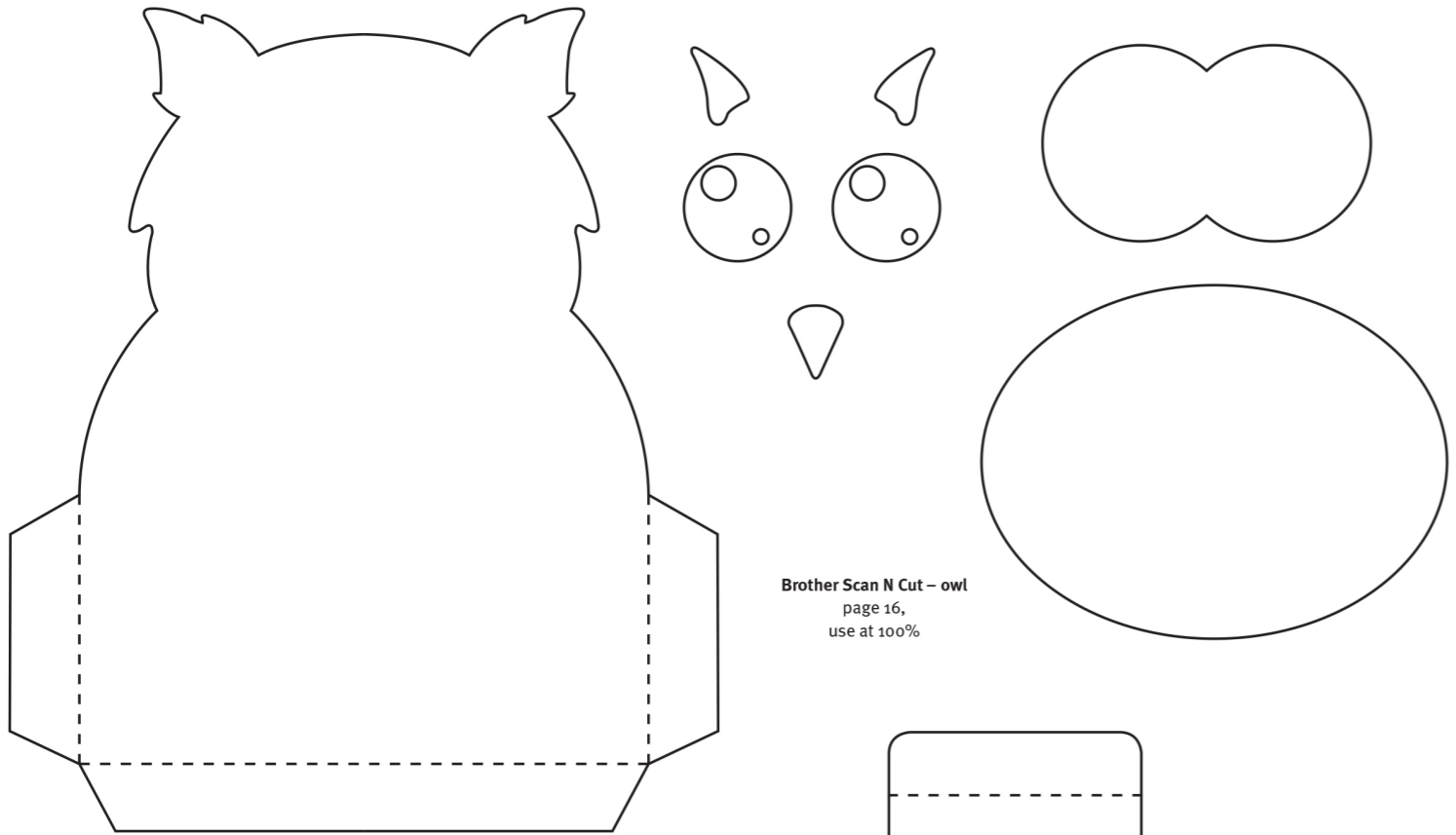

Brother Scan N Cut – owl
page 16,
use at 100%

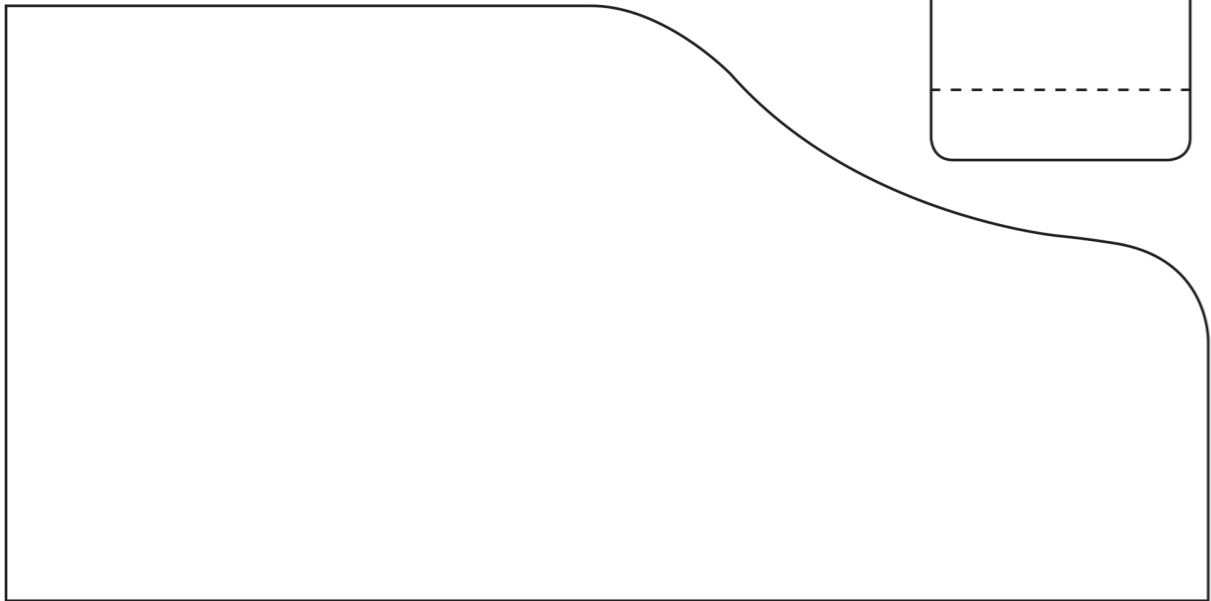
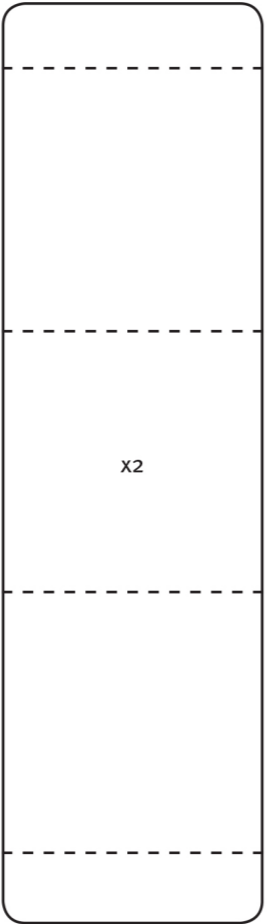
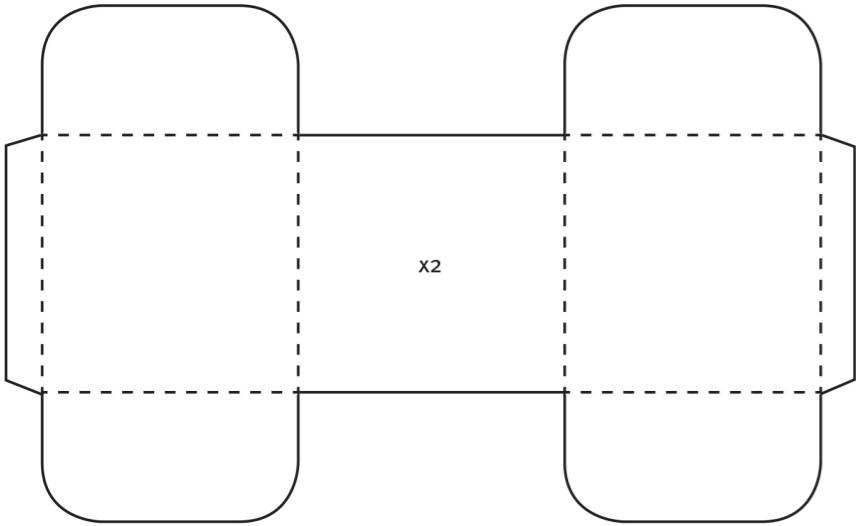

Cut ———
Fold - - - - -

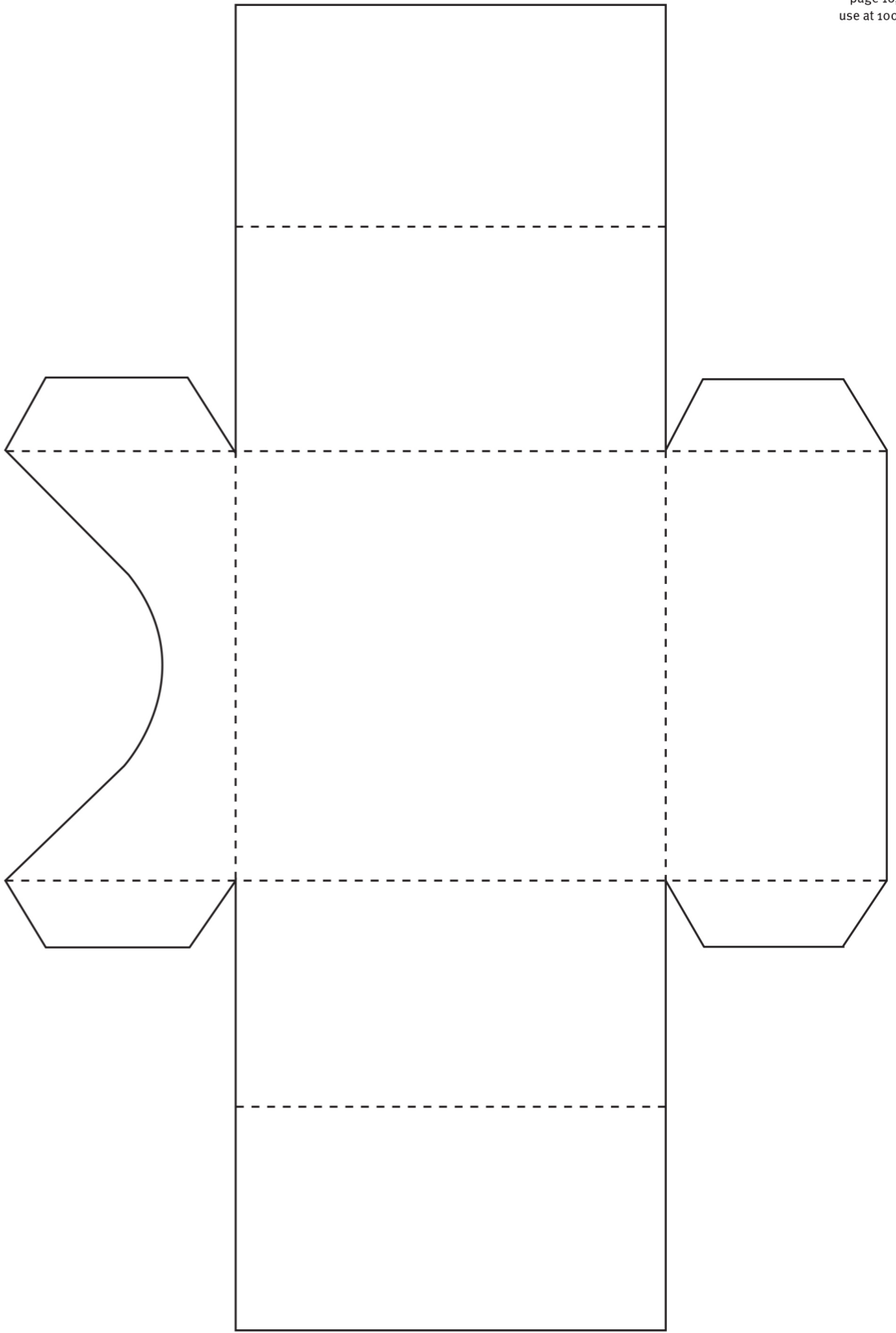

Cut ———
Fold - - - - -

Cut ———
Fold - - - - -

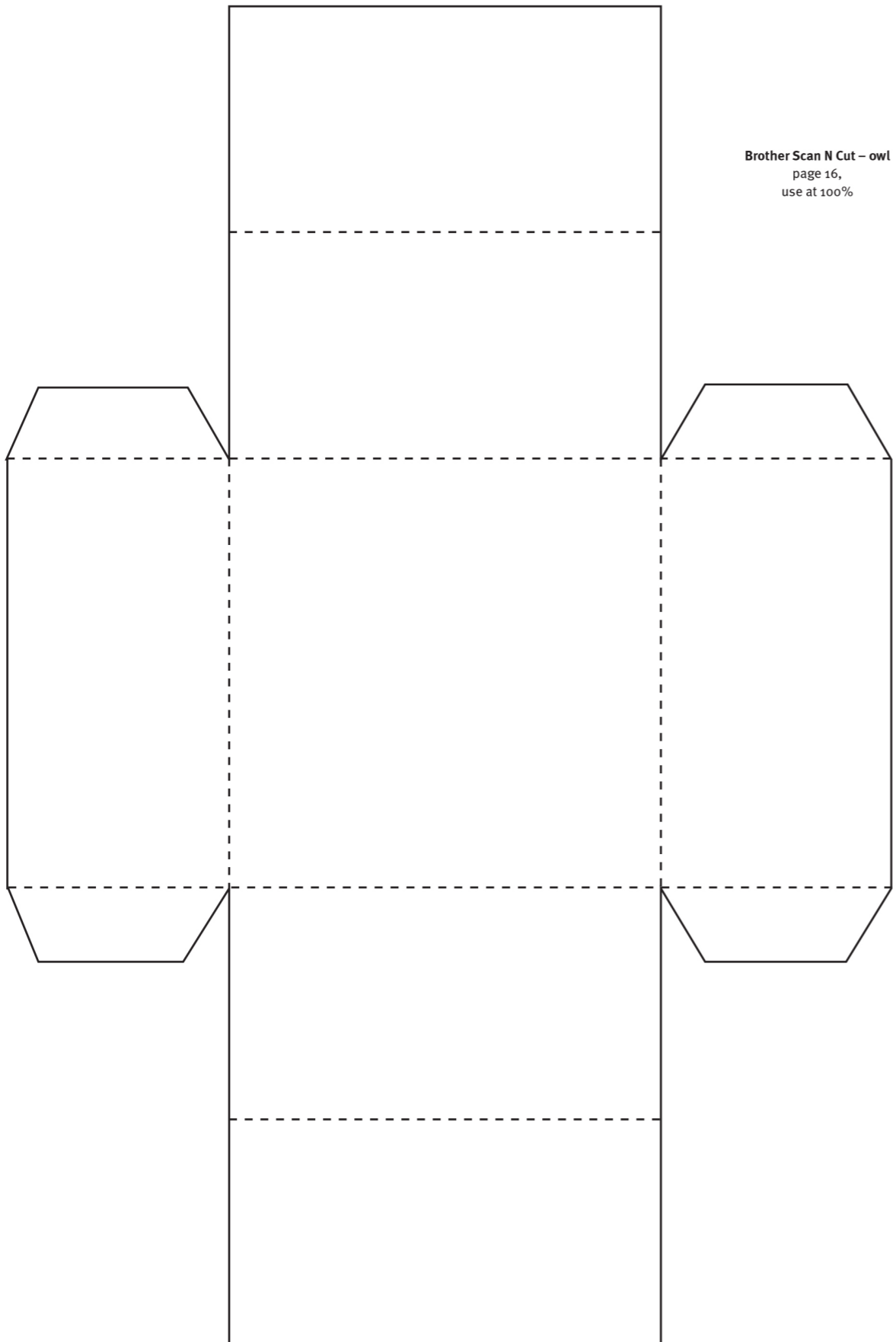

Cut ———
Fold - - - - -

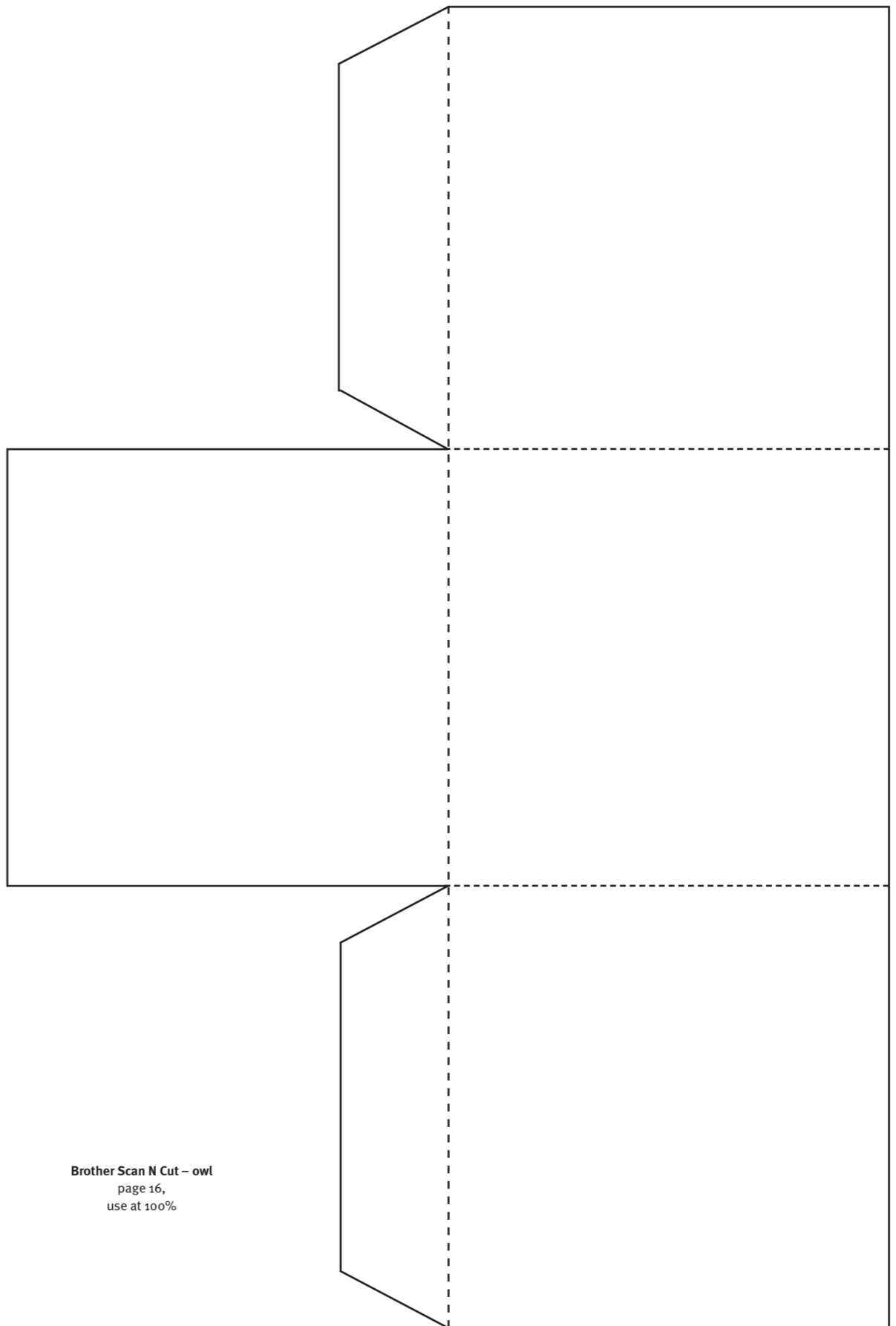

Cut ———
Fold - - - - -

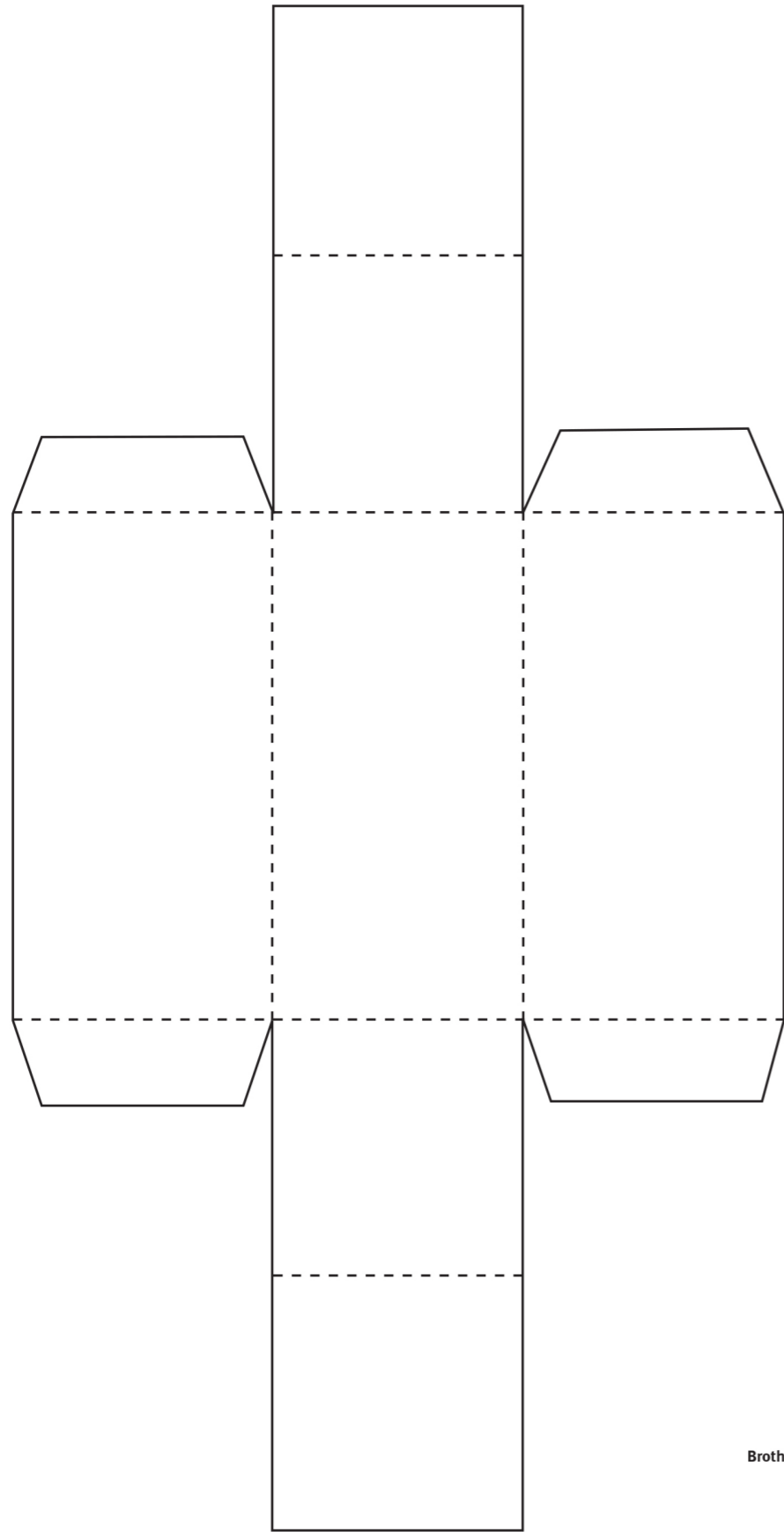

Brother Scan N Cut – owl
page 16,
use at 100%

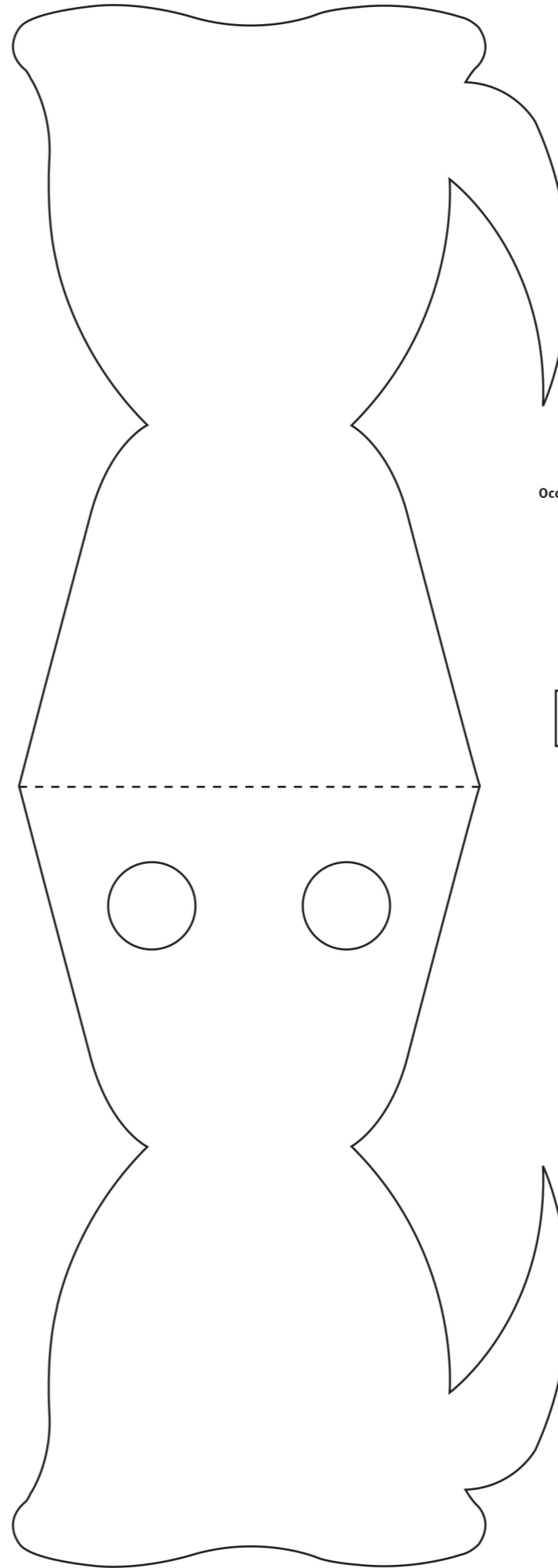

Occasions – dog card
page 51,
use at 100%

Cut ———
Fold - - - - -

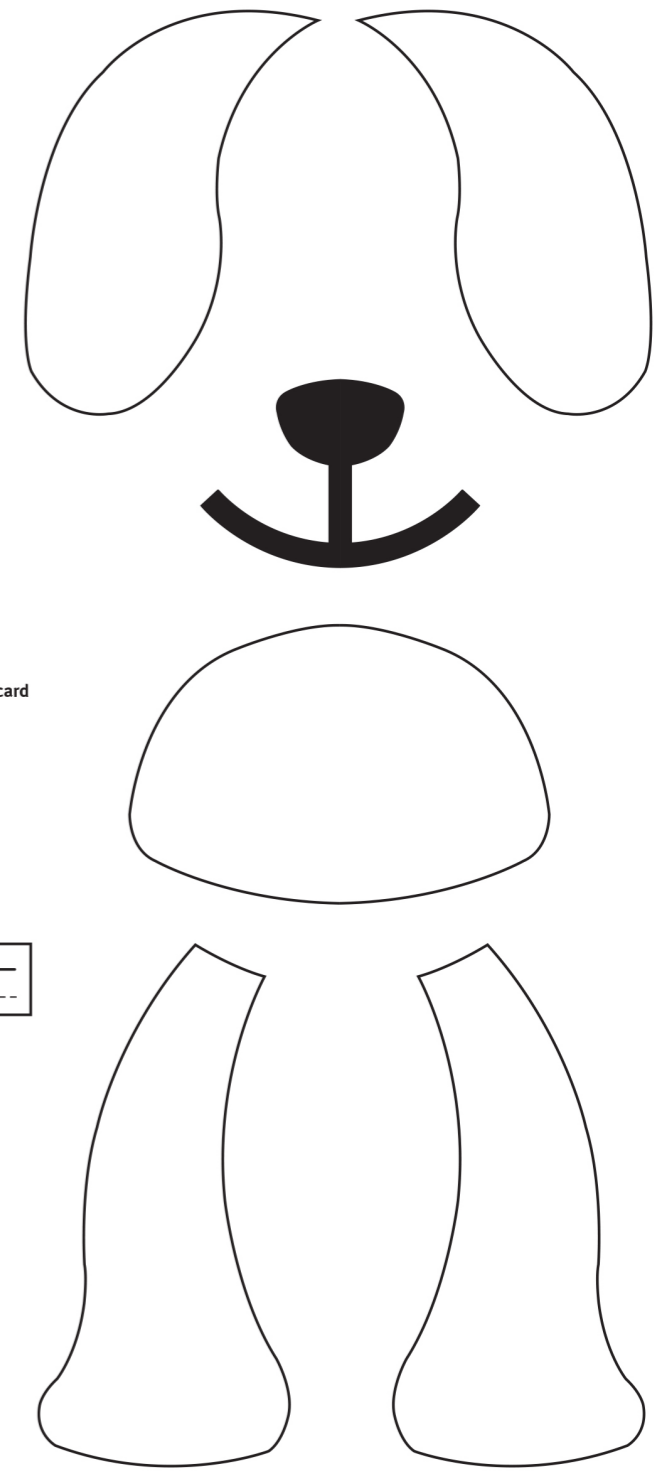

Frog prince printables
page 18,
use at 100%

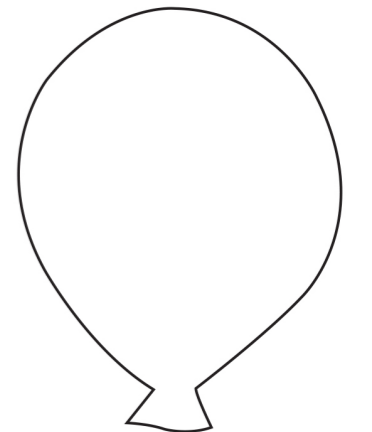

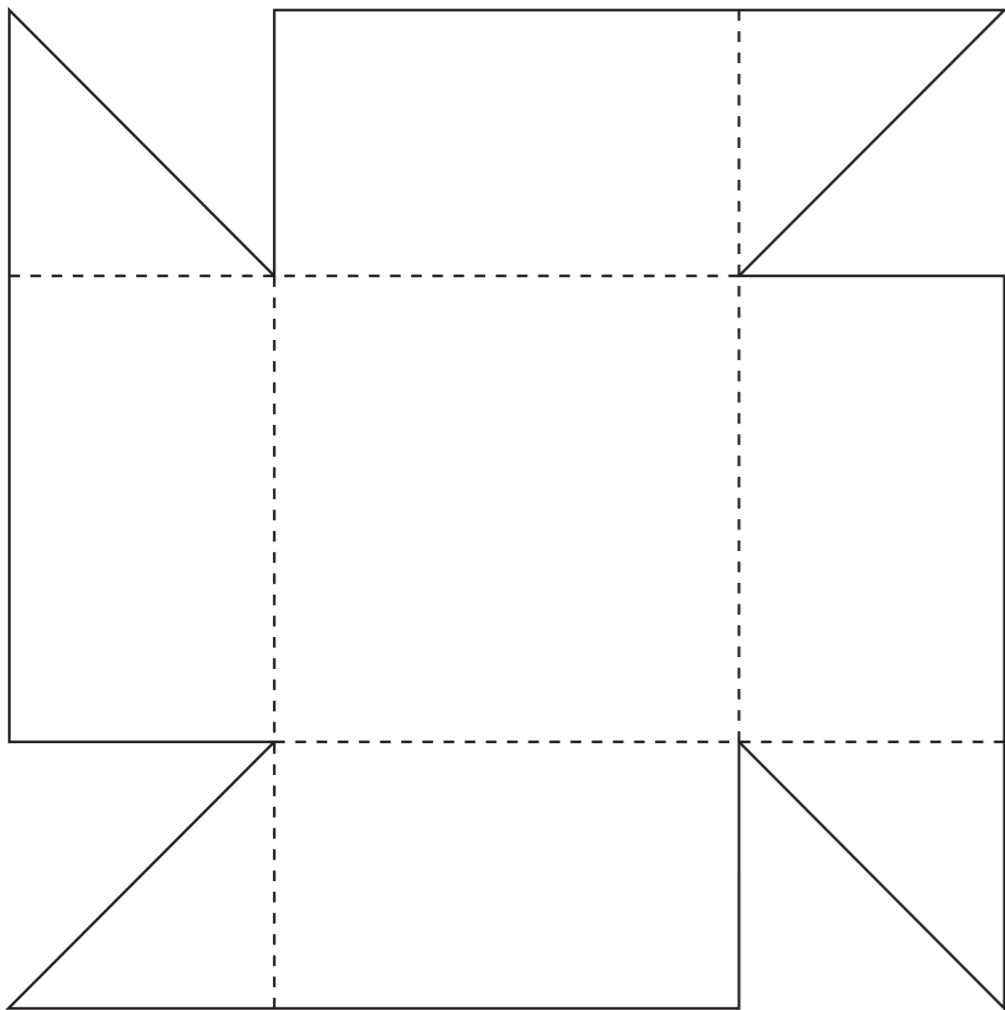

Cut ———
Fold - - - - -

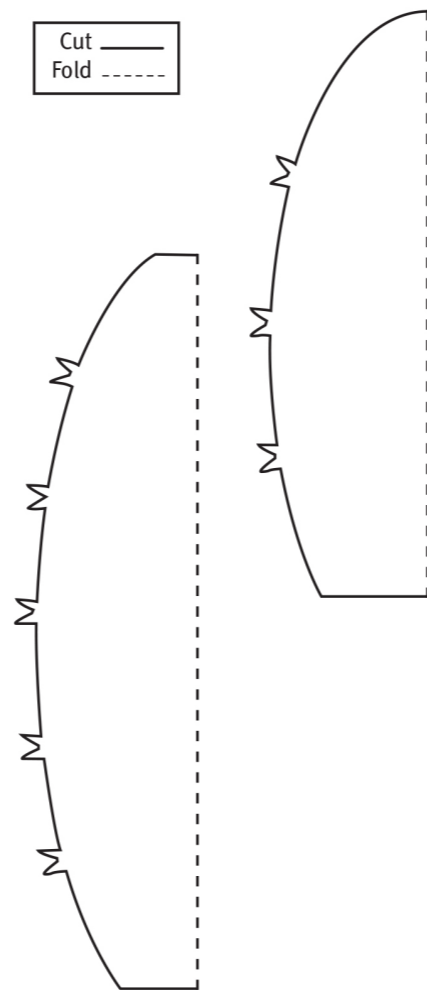

Cut ———
Fold - - - - -

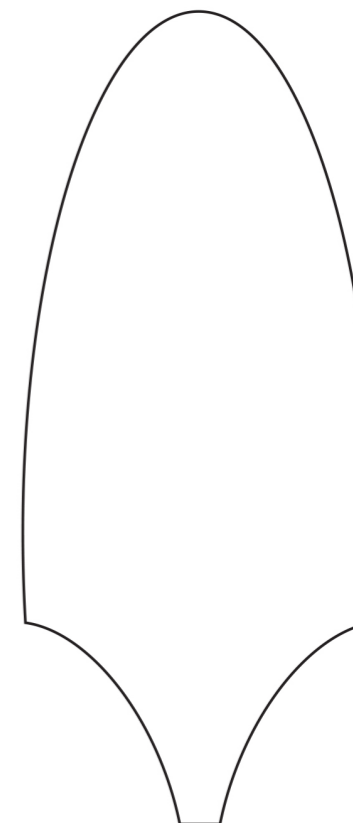
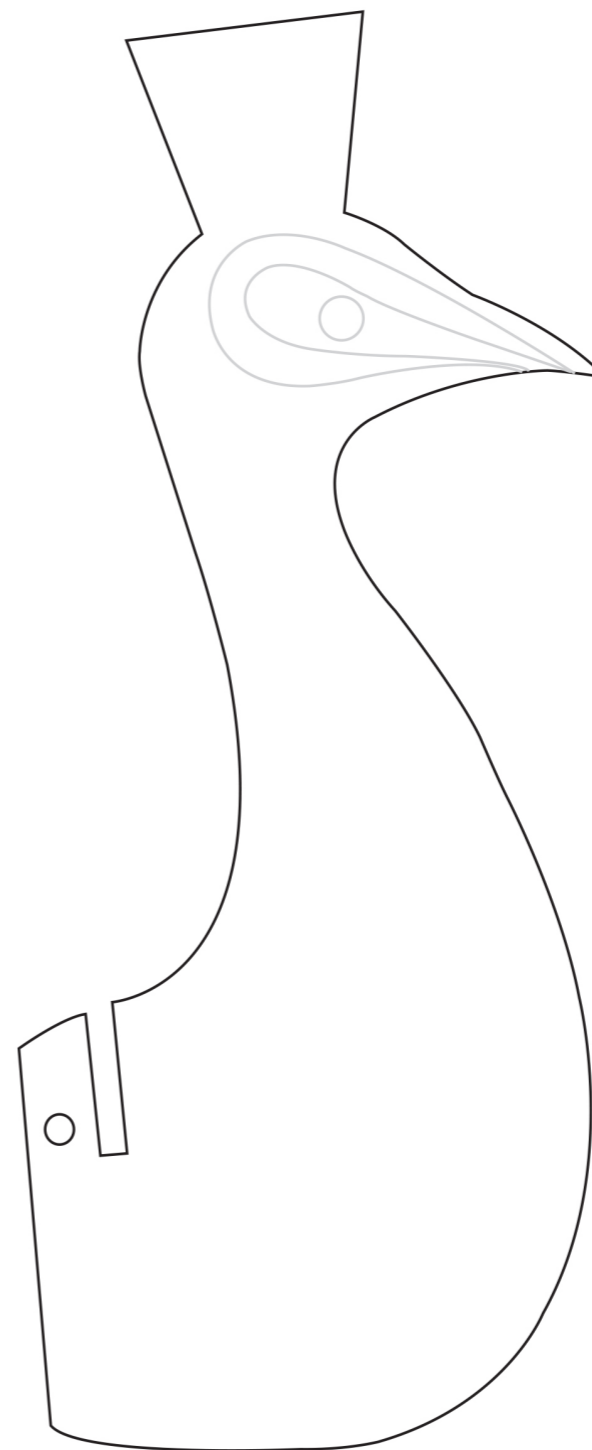

Gift Style,
page 36,
use at 100%

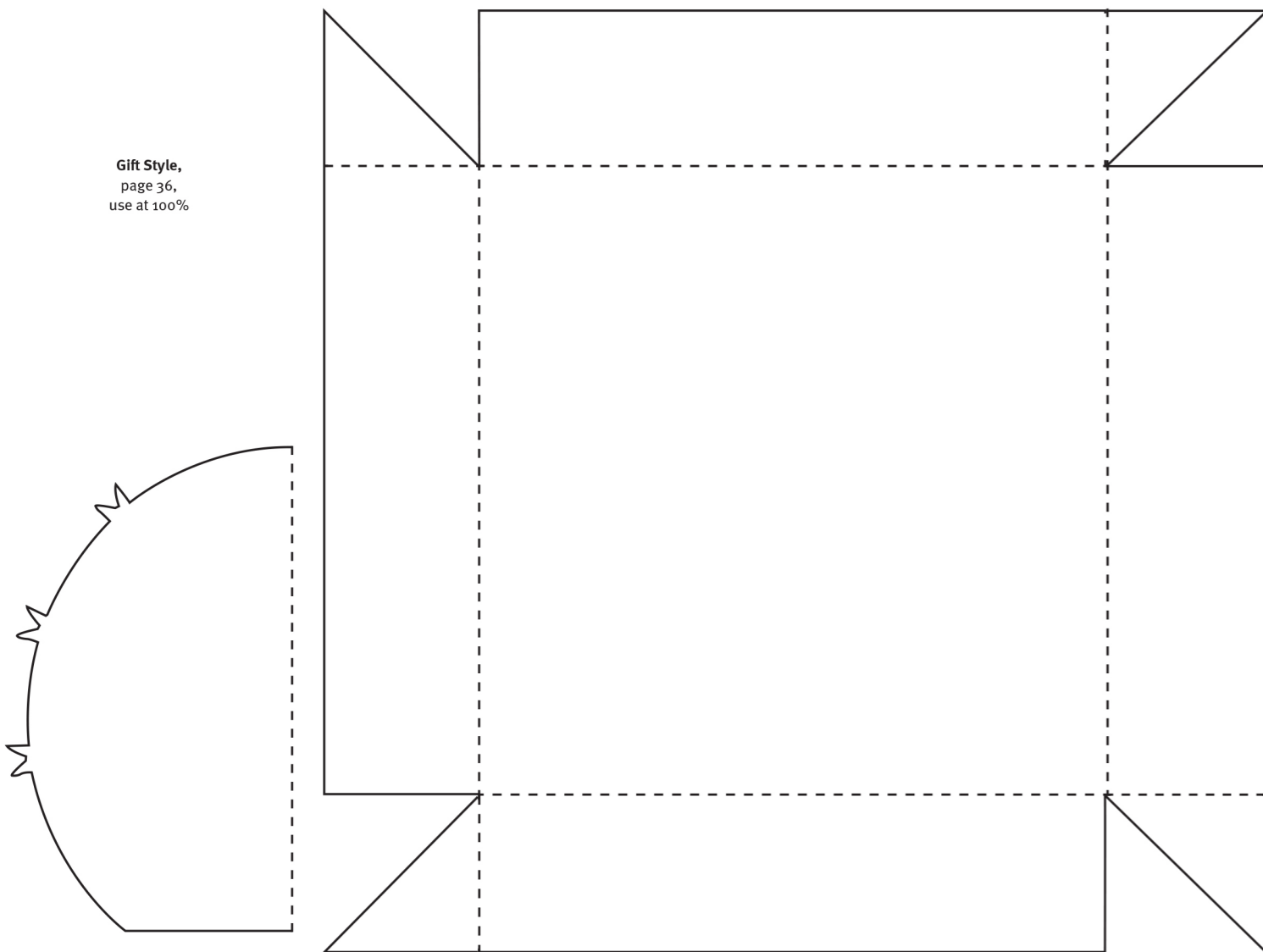

Home Style
page 66,
use at 100%

Cut ———
Fold - - - - -

