

Your free *templates*

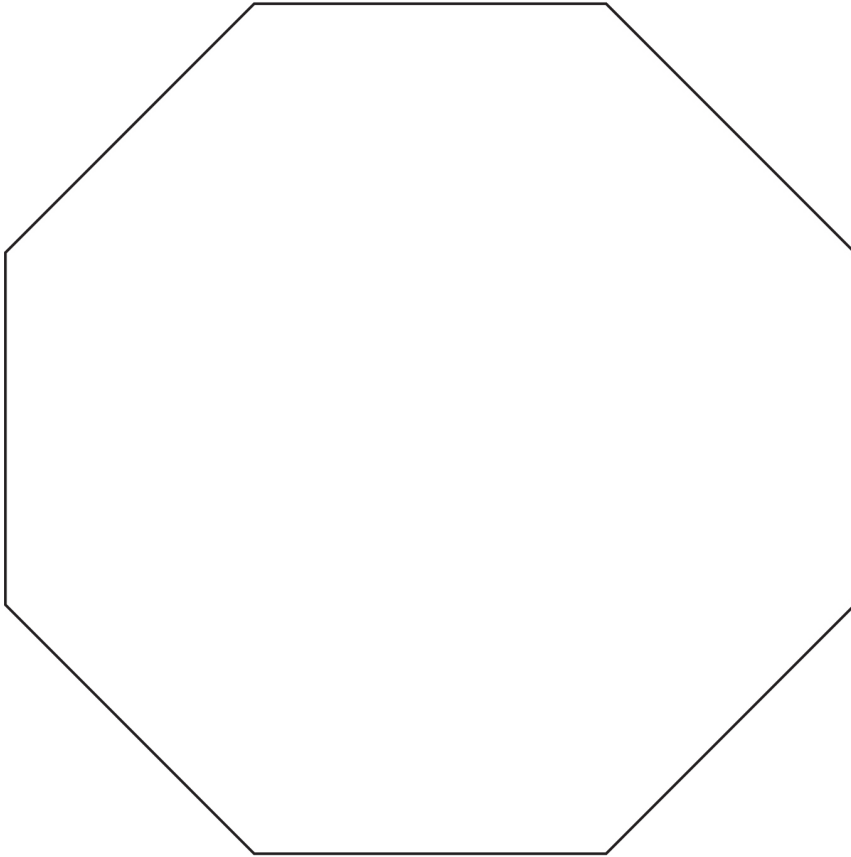

All the templates & outlines you'll need
for the projects in issue 195



Blackboard project
page 16,
use at 100%

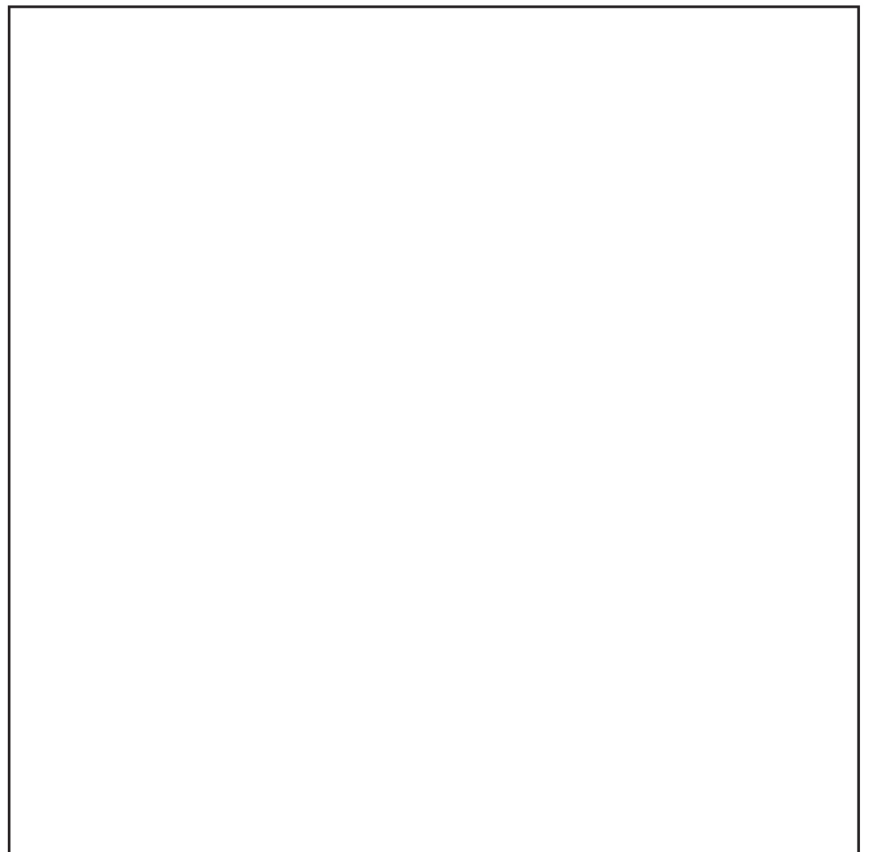

Cut	———
Mountain fold	- - - - -
Valley fold

Cut ———
 Mountain fold - - - - -
 Valley fold

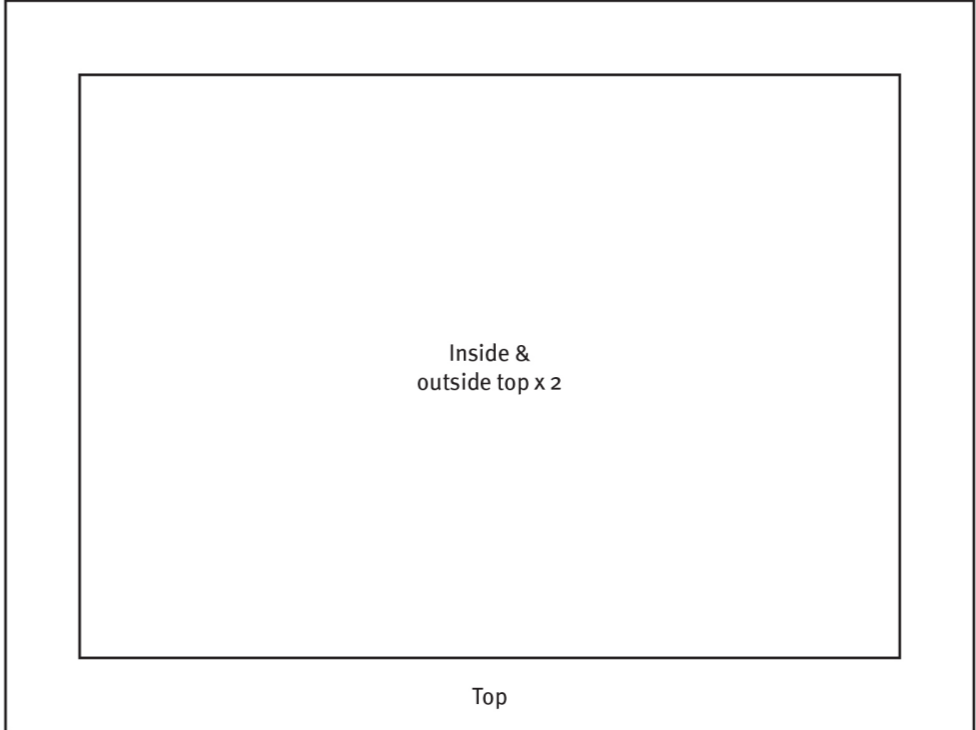
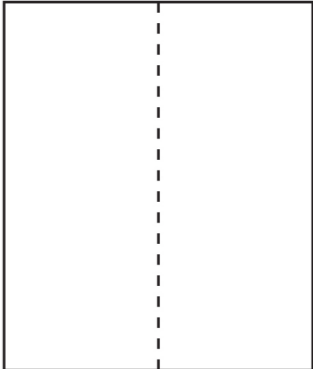
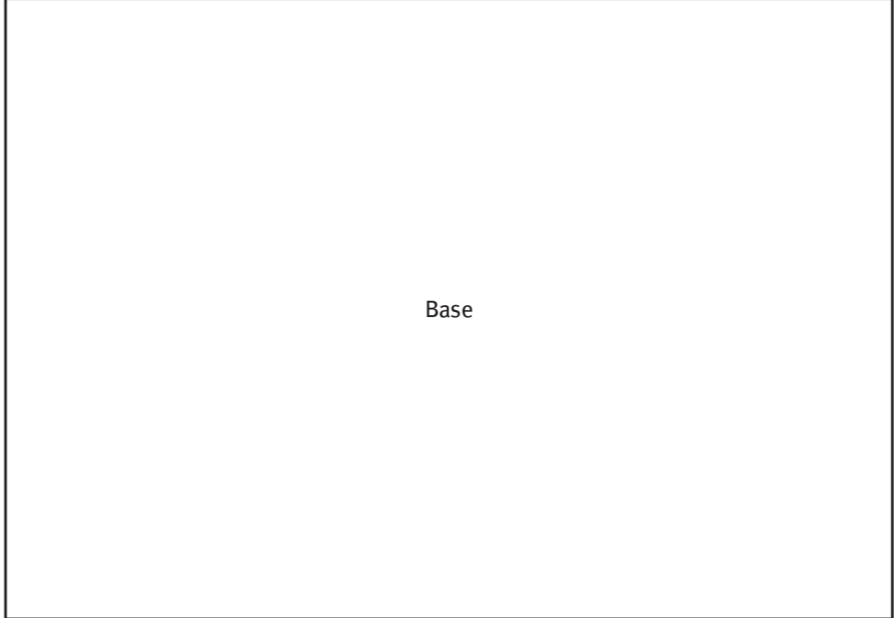
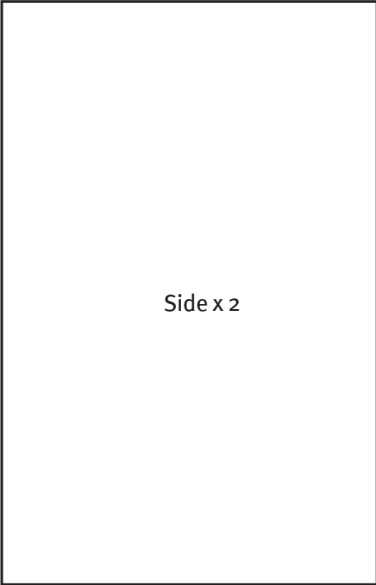
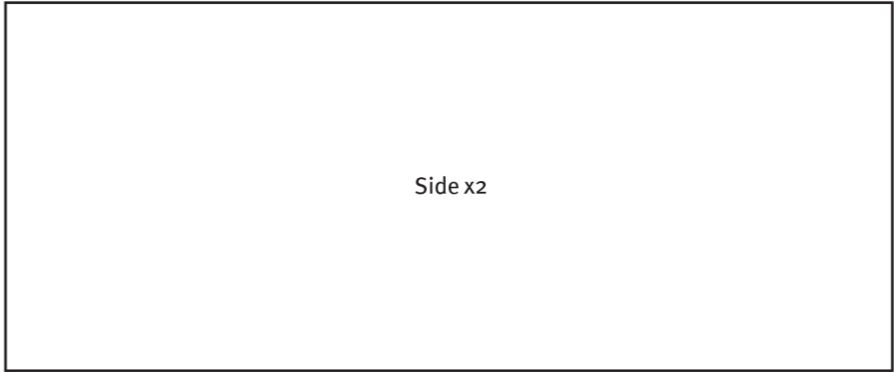
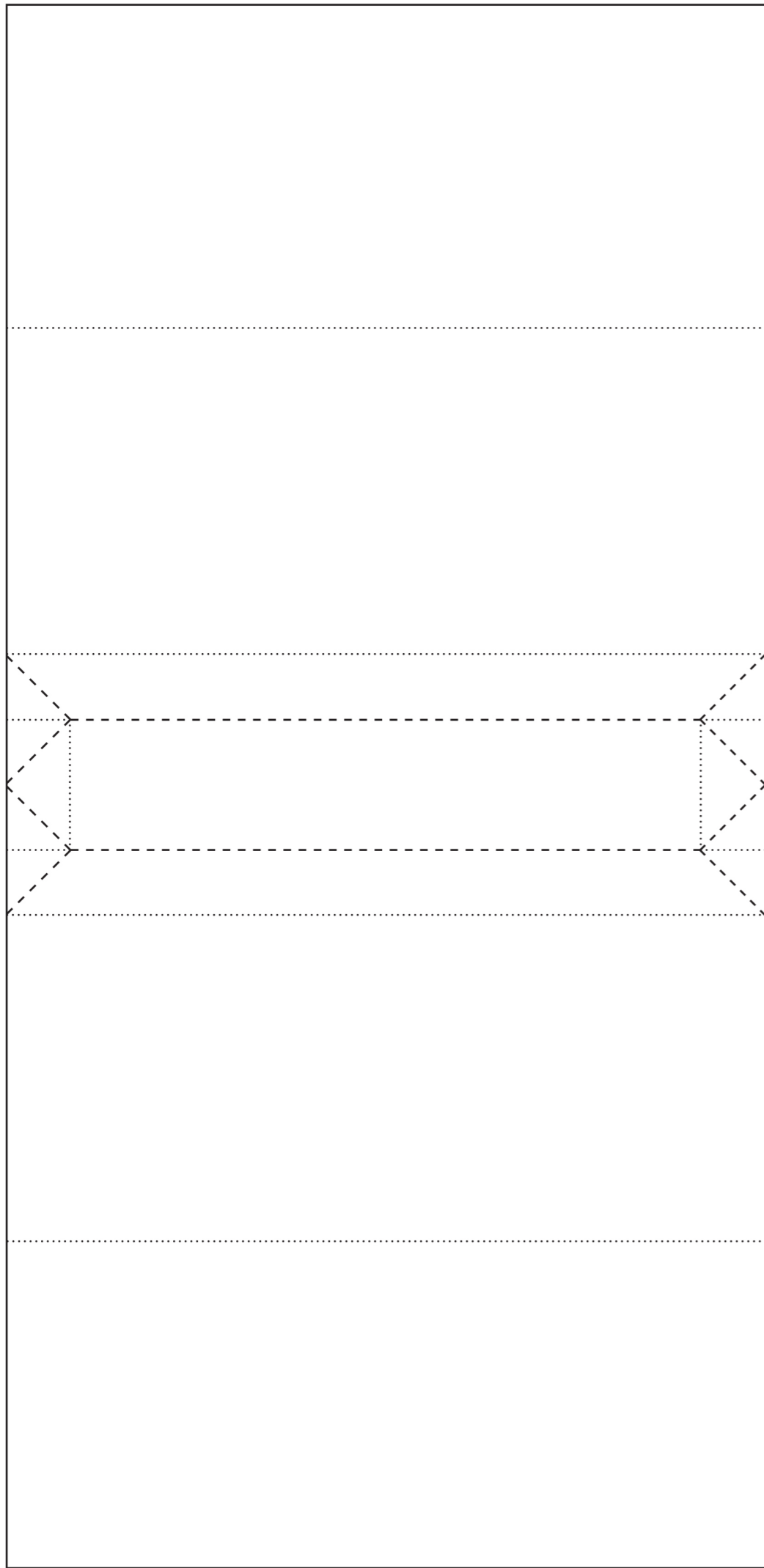

Ready Steady Craft –
 treasure box
 page 68,
 use at 100%

Cut ———
 Fold - - - - -

Cut ———
Fold - - - - -

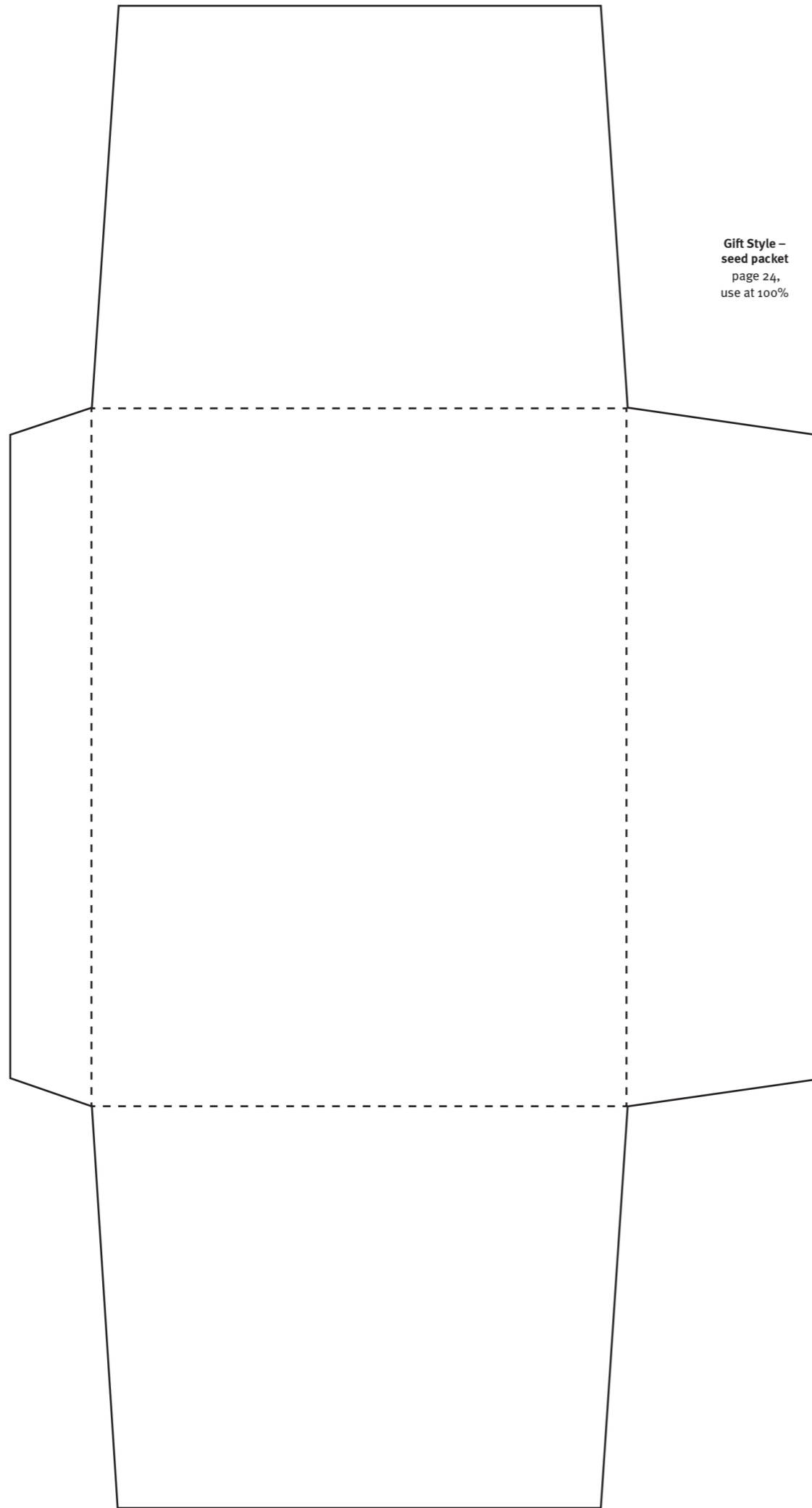

Gift Style –
seed packet
page 24,
use at 100%

Gift Style –
seed packet
page 24,
use at 100%

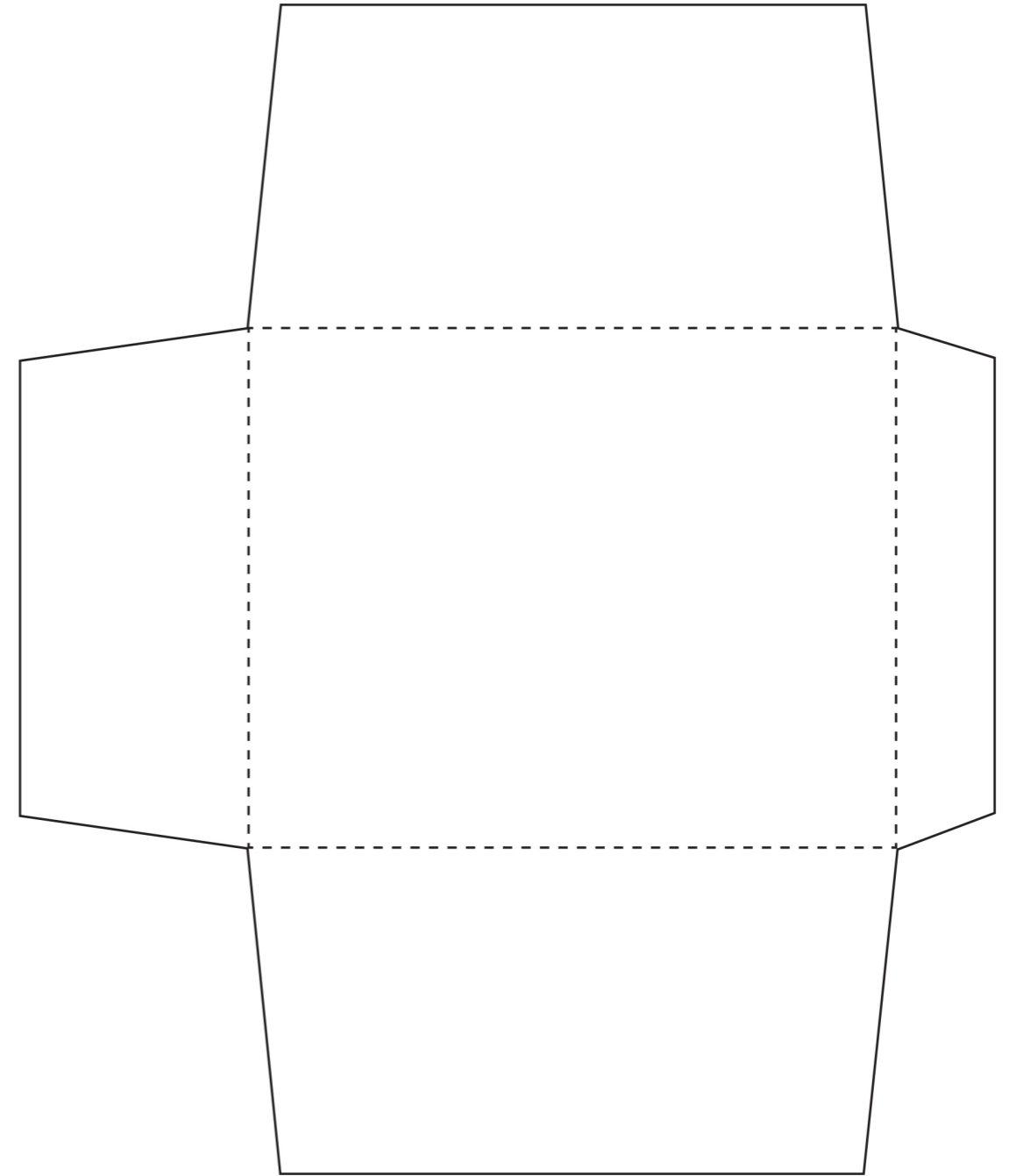

Cut ———
Fold - - - - -

Gift Style –
seed packet
page 24,
use at 100%

CONTENTS :-
.....
.....
SOW BY :-
.....
.....

CONTENTS :-
.....
.....
SOW BY :-
.....
.....

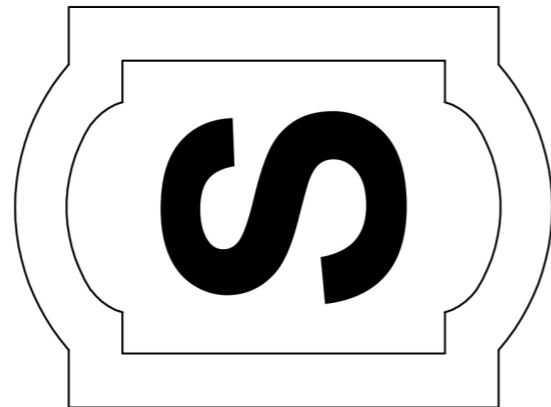
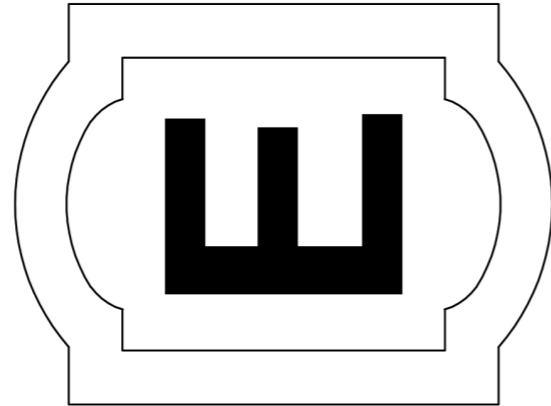
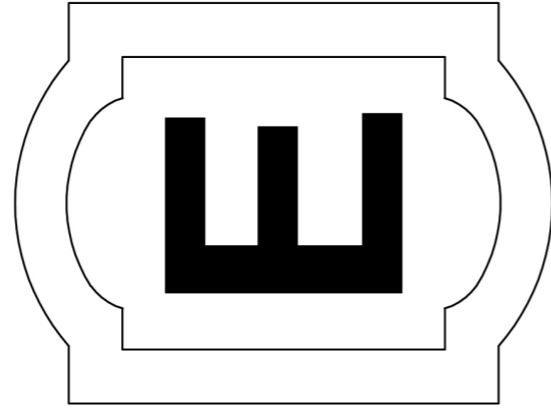
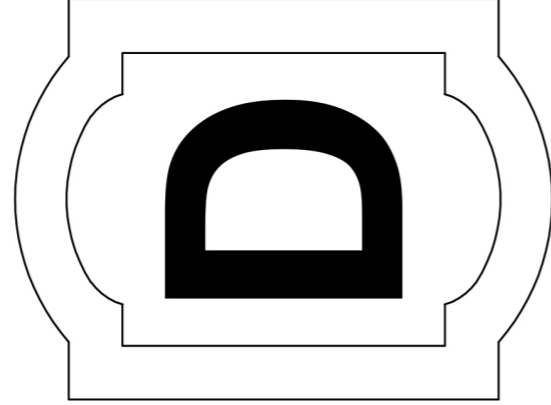
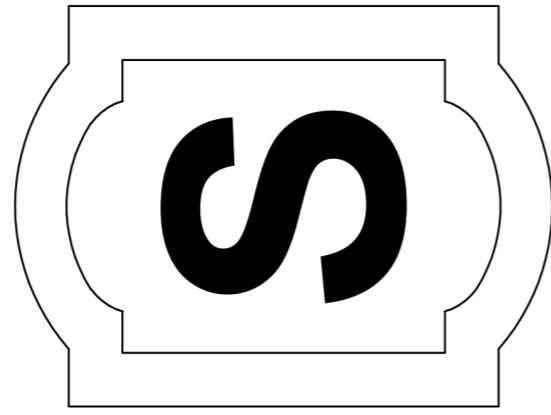

Cut ———
Mountain fold - - - - -
Valley fold
.....

Printables – pop-up
kitchen card
page 8,
use at 100%

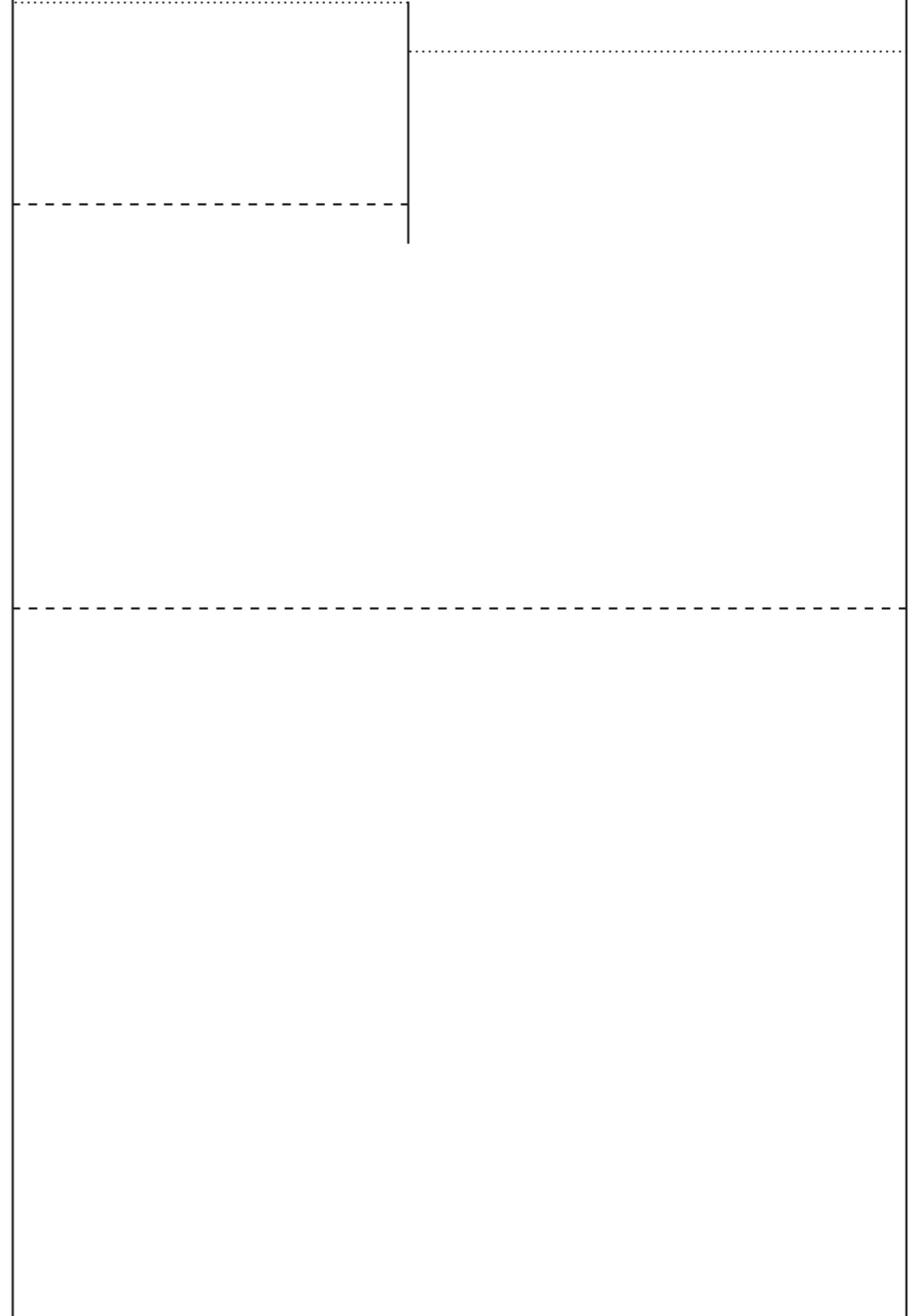

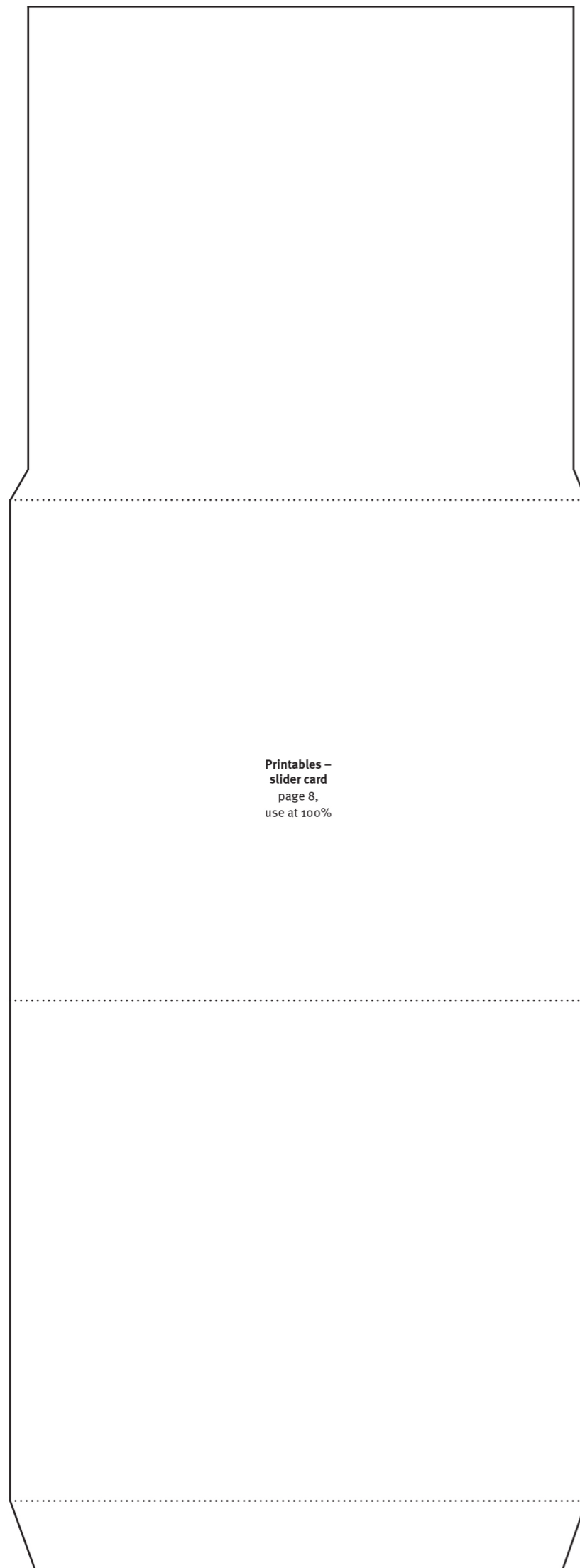

Printables -
slider card
page 8,
use at 100%

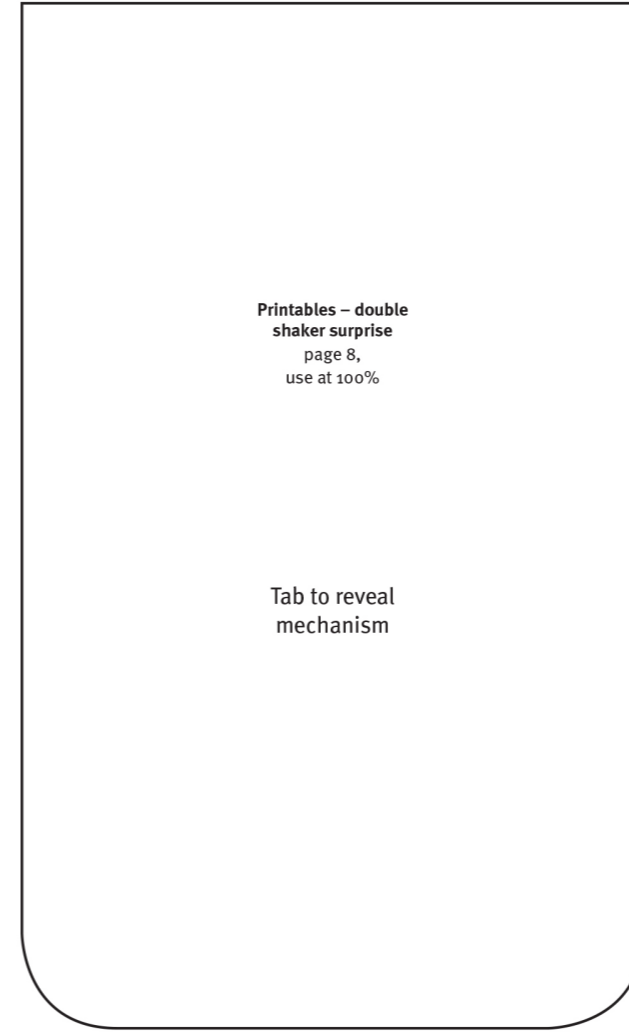

Printables - double
shaker surprise
page 8,
use at 100%

Tab to reveal
mechanism

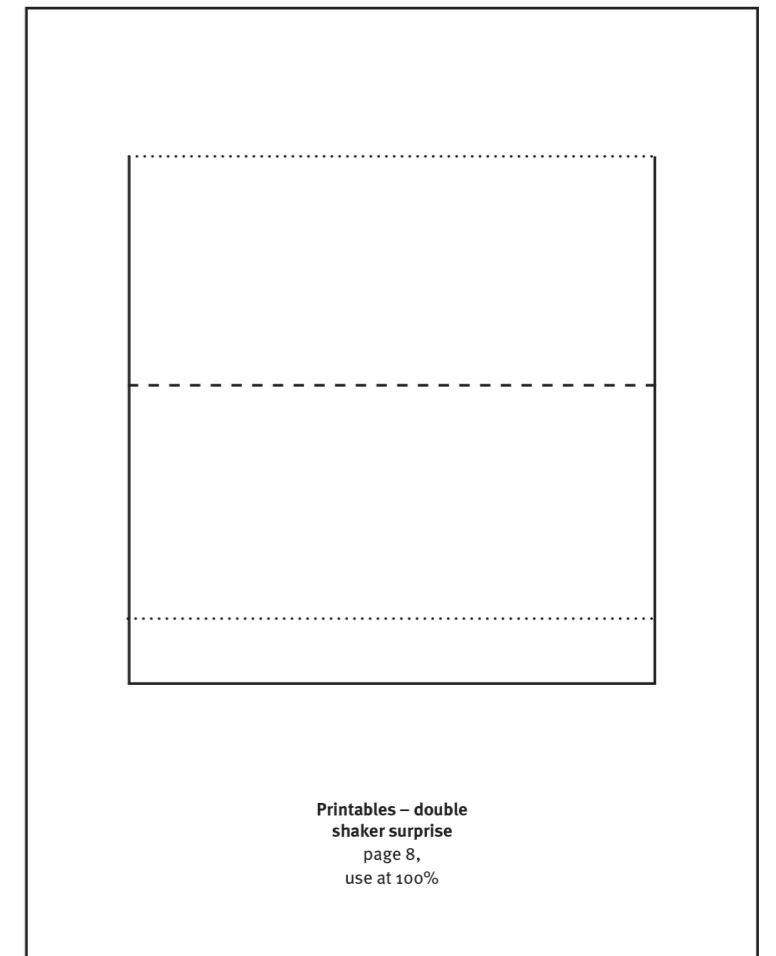

Printables - double
shaker surprise
page 8,
use at 100%

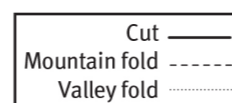

Cut ———
Mountain fold - - - - -
Valley fold ·····