

Your free *templates*

All the templates & outlines you'll need for the projects in issue 189

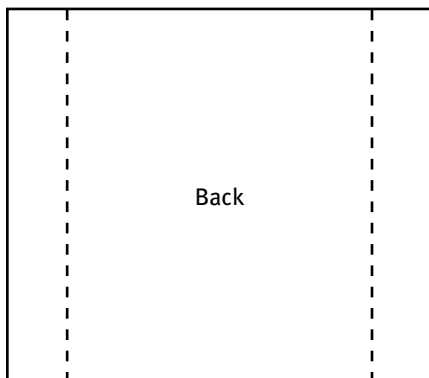

Ready Steady Craft
– Sewing Box
page 68,
use at 200%

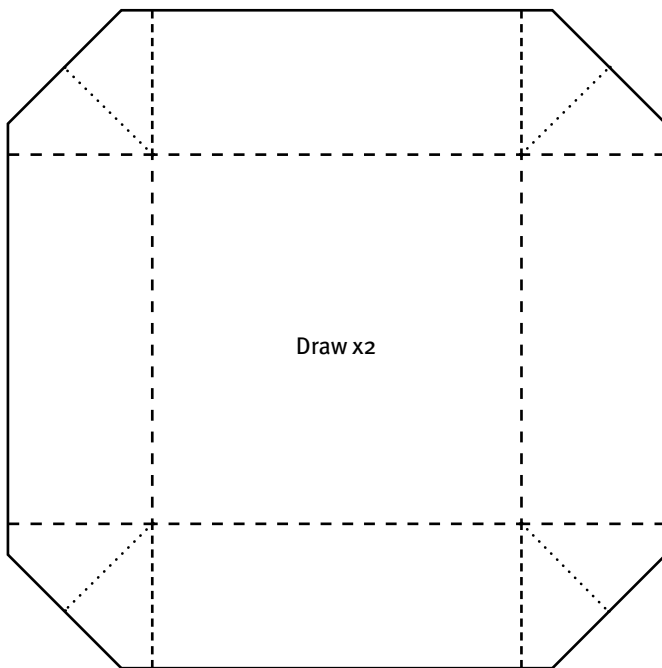
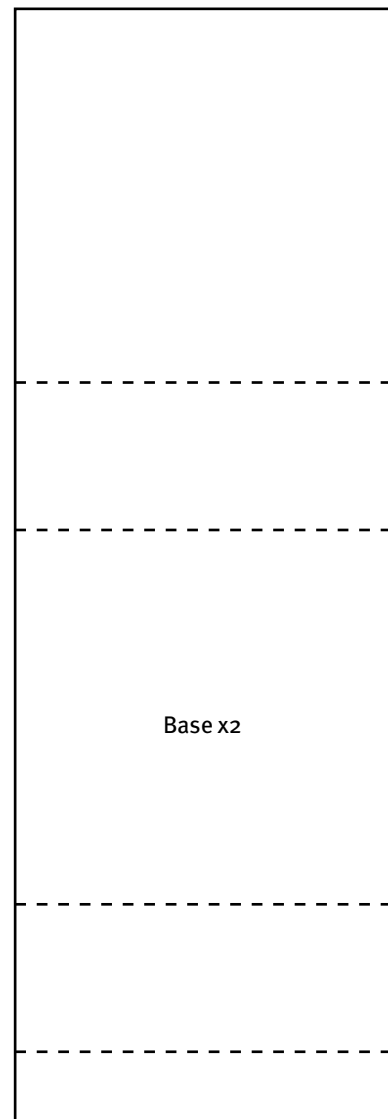

Cut ———
Mountain Fold - - - - -
Valley Fold ·····

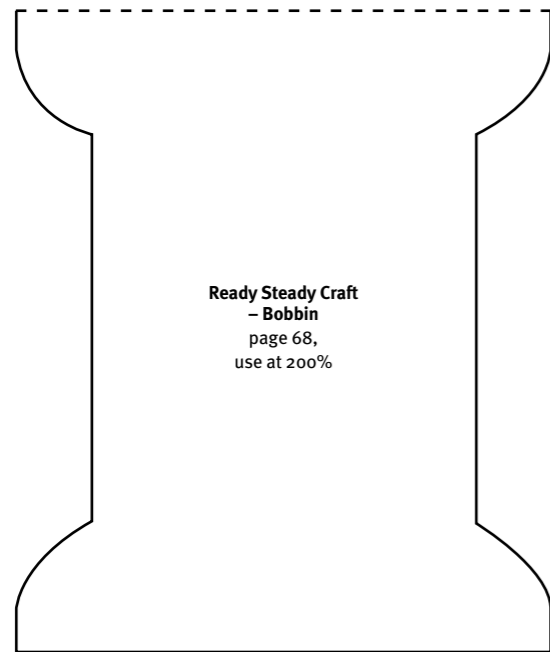

Ready Steady Craft
- Bobbin
page 68,
use at 200%

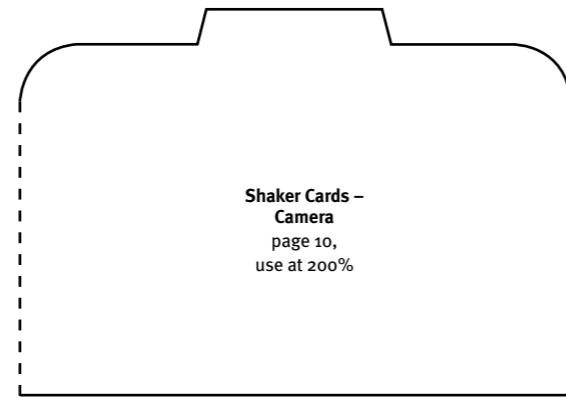

Shaker Cards -
Camera
page 10,
use at 200%

Cut ———
Mountain Fold - - - - -
Valley Fold ······

Find
all shapes
FULL-SIZE
ready to use on
our website

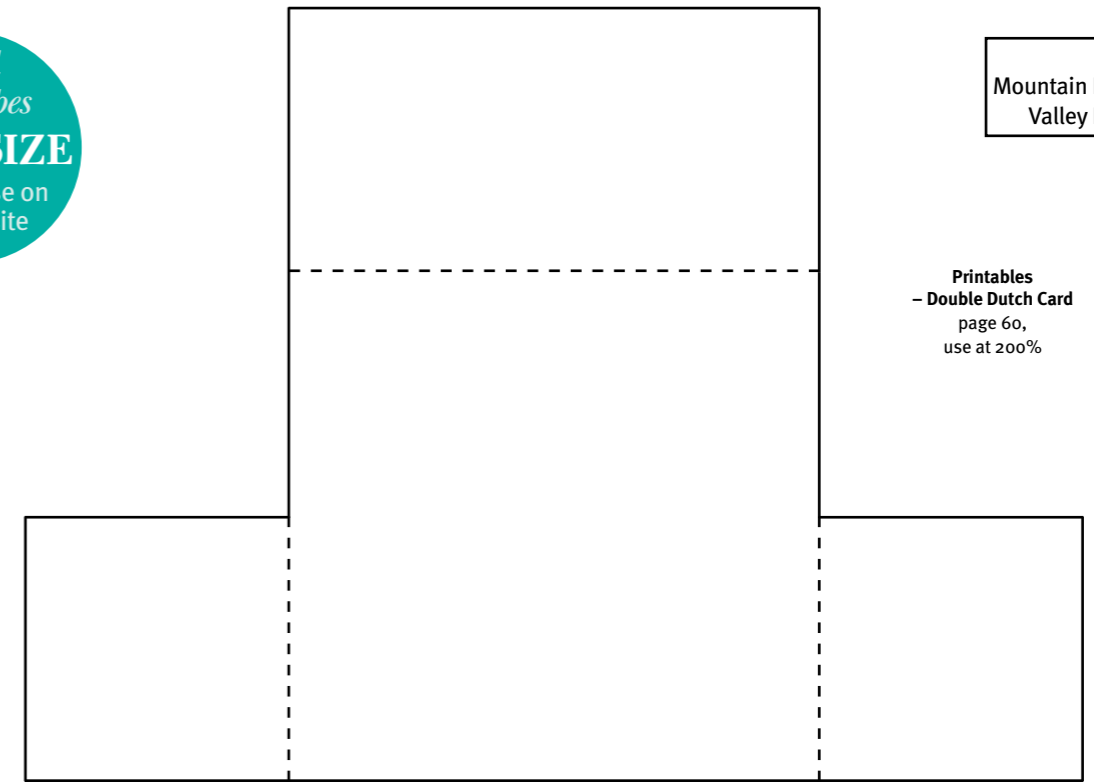

Printables
- Double Dutch Card
page 60,
use at 200%

Cut ———
Mountain Fold - - - - -
Valley Fold ······

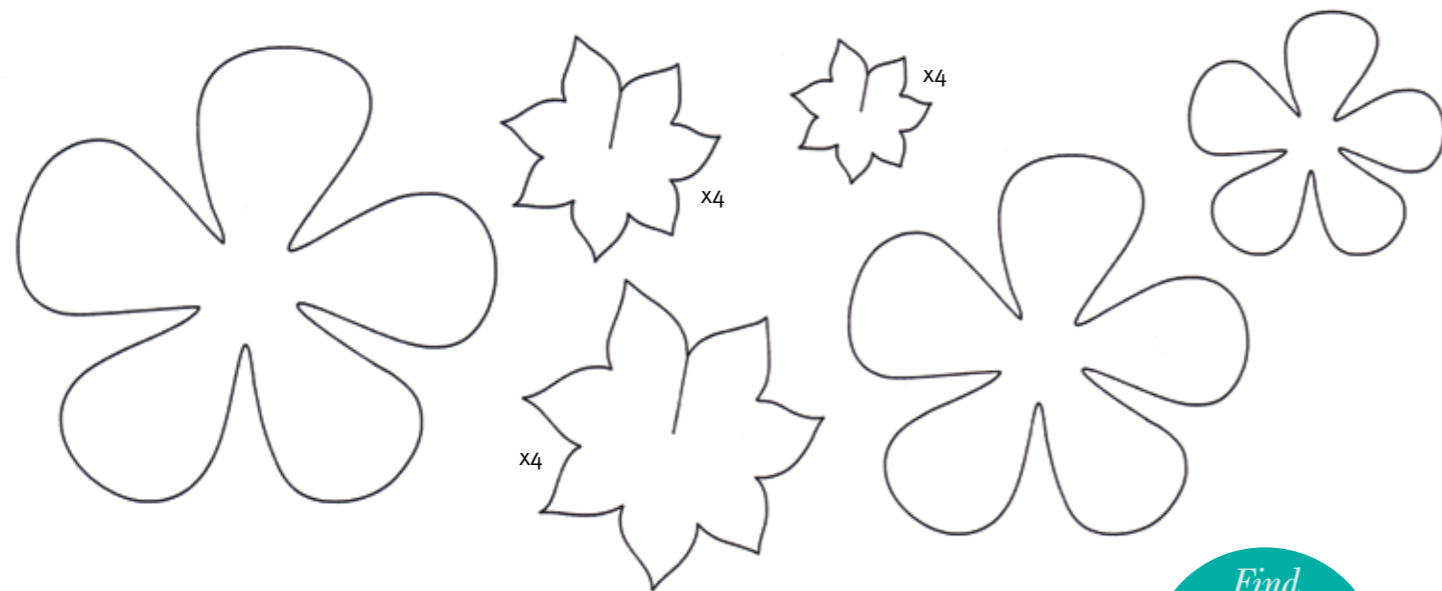

Scan N Cut
page 18,
use at 200%

Find
all shapes
FULL-SIZE
ready to use on
our website

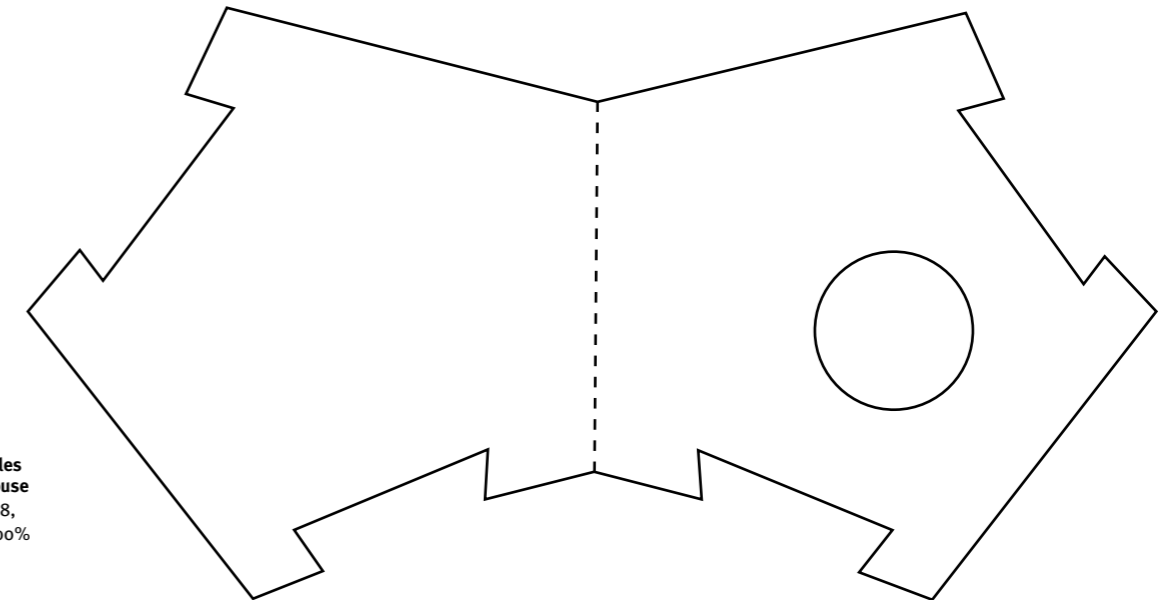
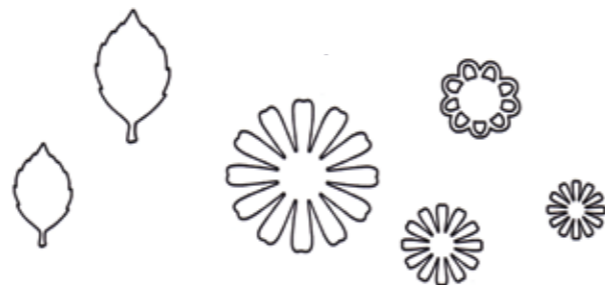

Printables
- Birdhouse
page 68,
use at 200%

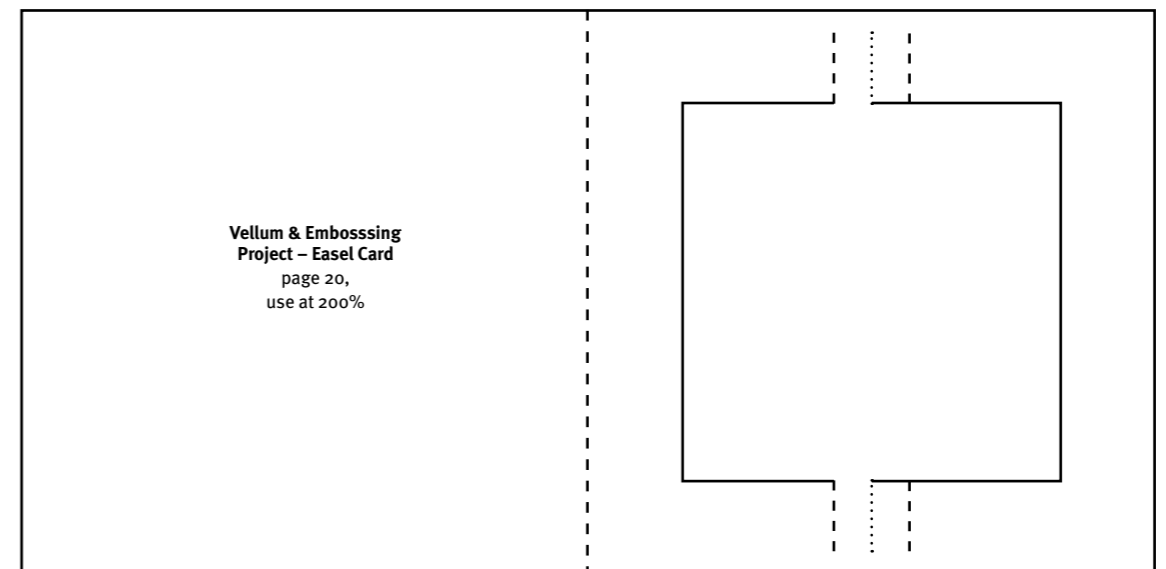

Vellum & Embossing
Project - Easel Card
page 20,
use at 200%

Find all shapes
FULL-SIZE
 ready to use on our website

Cut ———
 Mountain Fold - - - - -
 Valley Fold ······

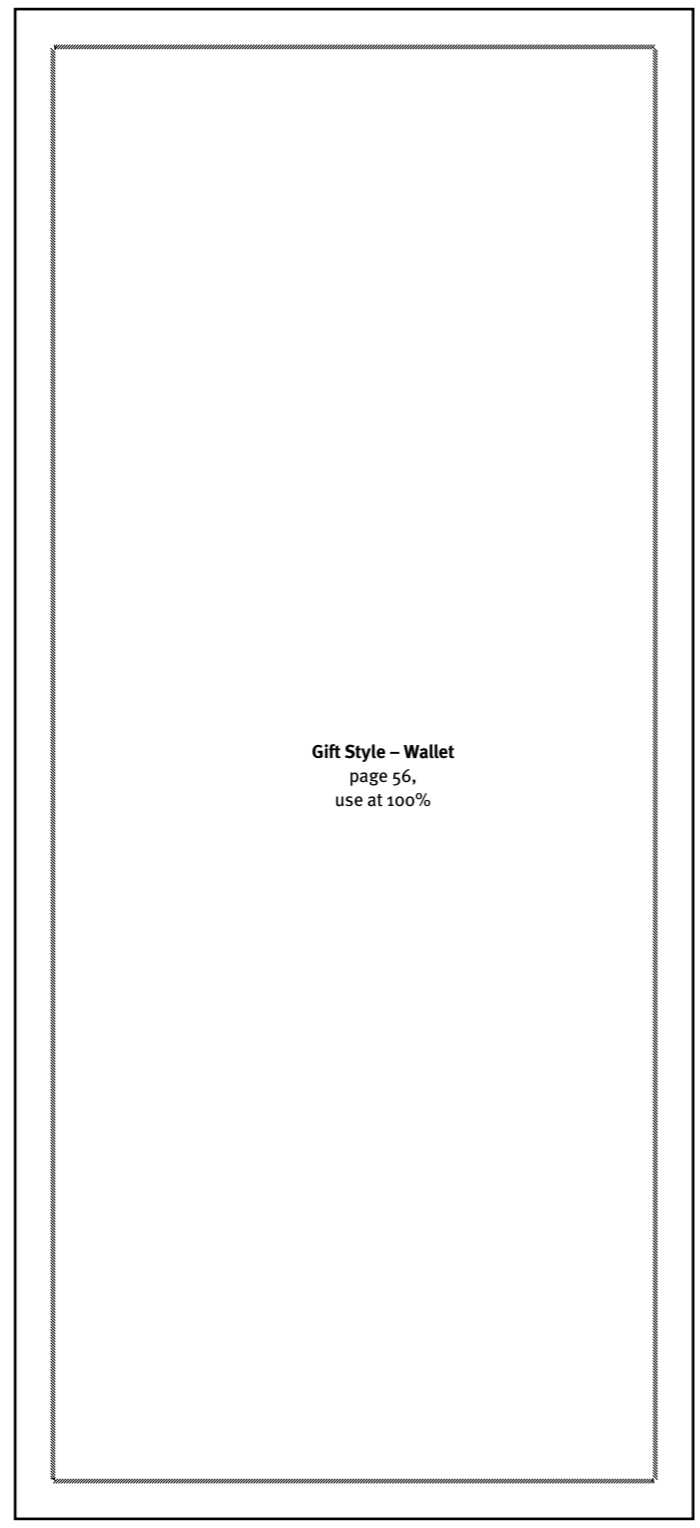
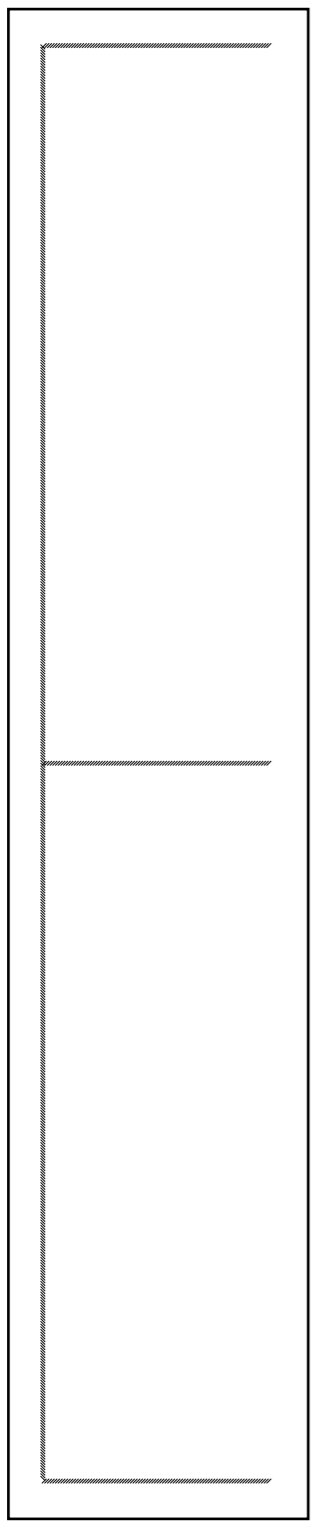

Gift Style – Wallet
 page 56,
 use at 100%

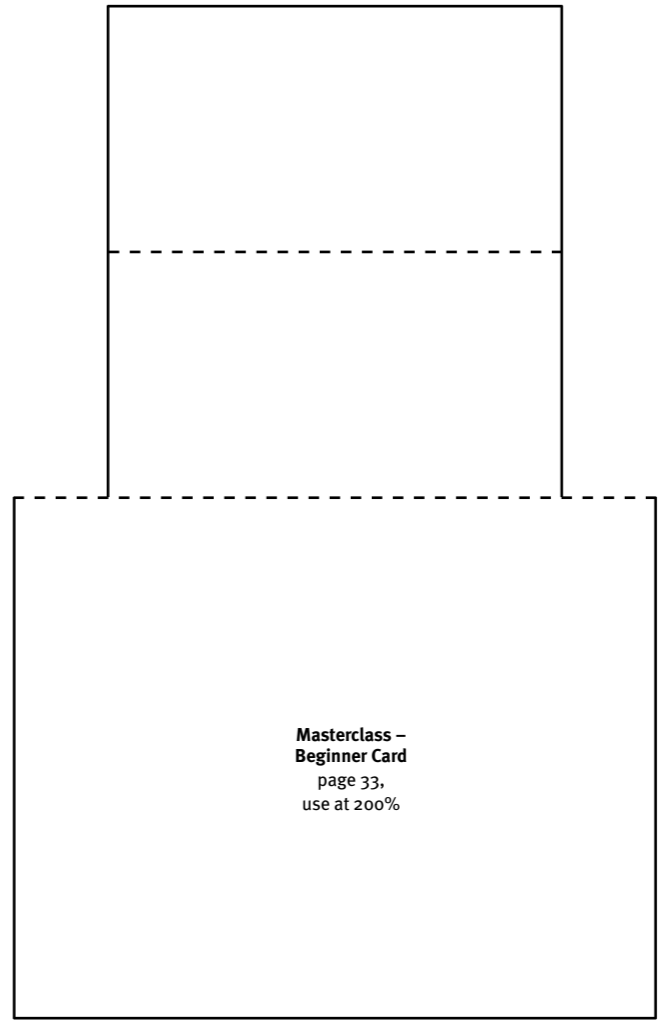

Masterclass –
 Beginner Card
 page 33,
 use at 200%

Masterclass –
 Beginner Card
 page 33,
 use at 100%

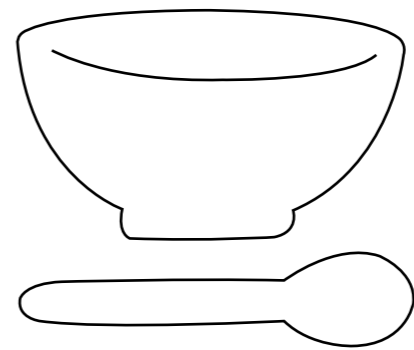

**A recipe for a
 Happy Birthday!**

1. Take one special lady.
2. Mix with good friends.
3. Add heaps of love.
4. Sprinkle with presents.
5. Serve with a slice of birthday cake!

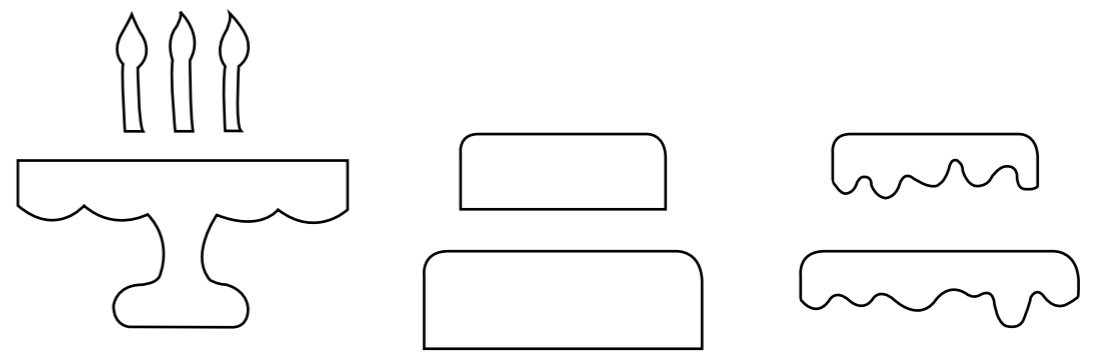

Cut ———
 Mountain Fold - - - - -
 Valley Fold ······
 Stitch ———