

TEMPLATES

Here are the templates you need to make the toy, breakfast makes, house bag, and face mask in *Simply Sewing* issue 70.

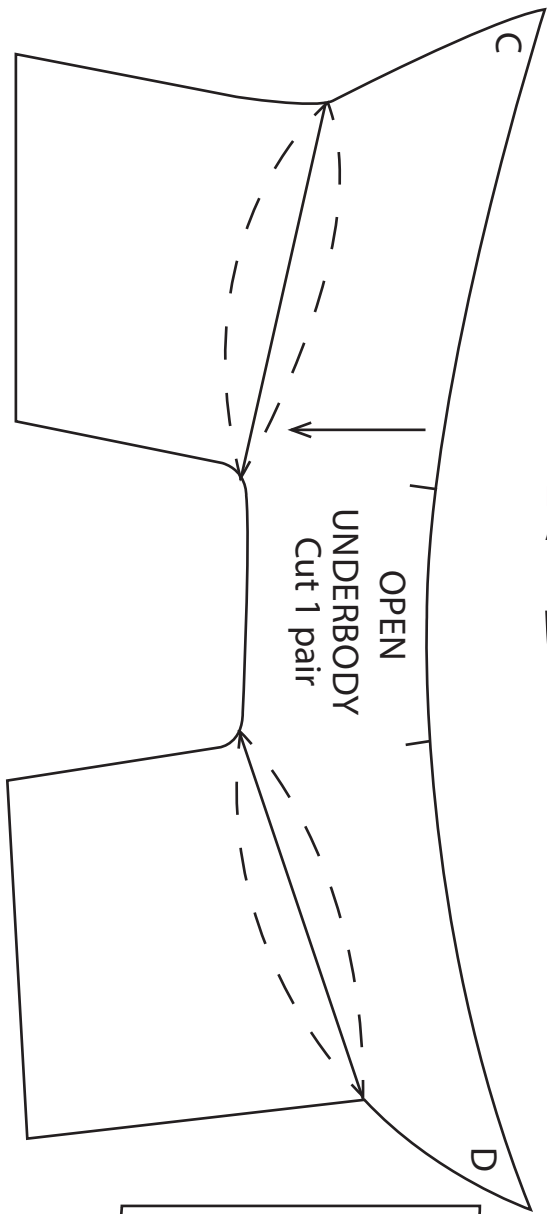

PIGLET TOY

PAGE 72
ACTUAL SIZE

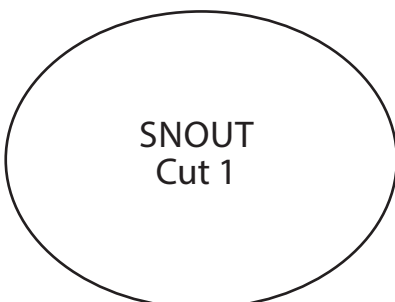
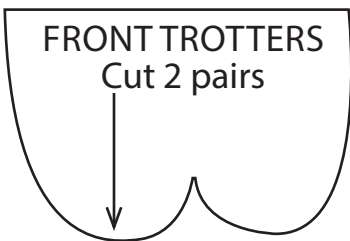
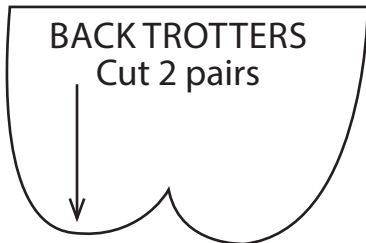
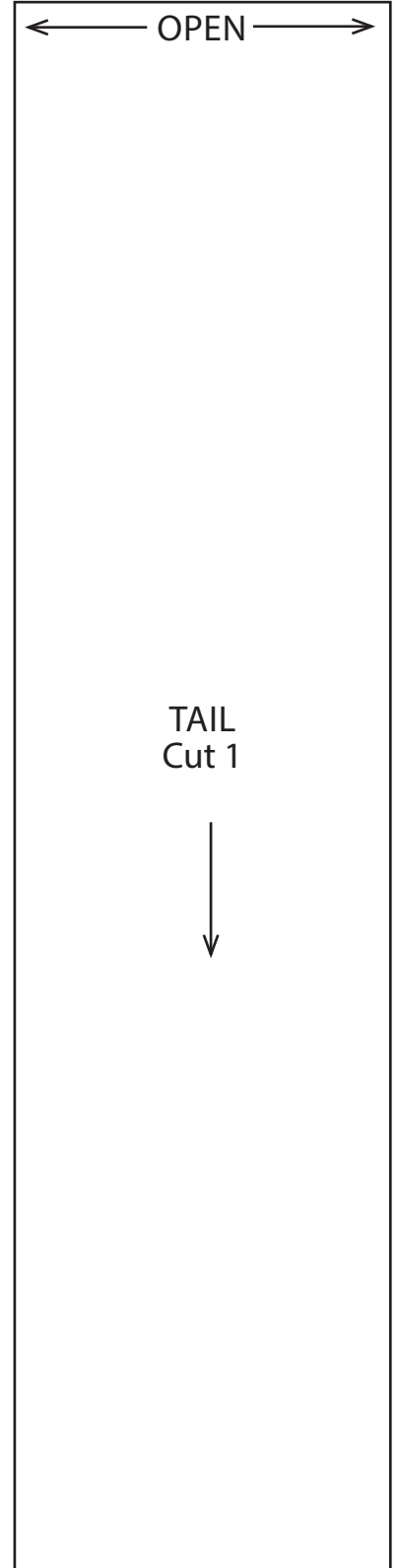
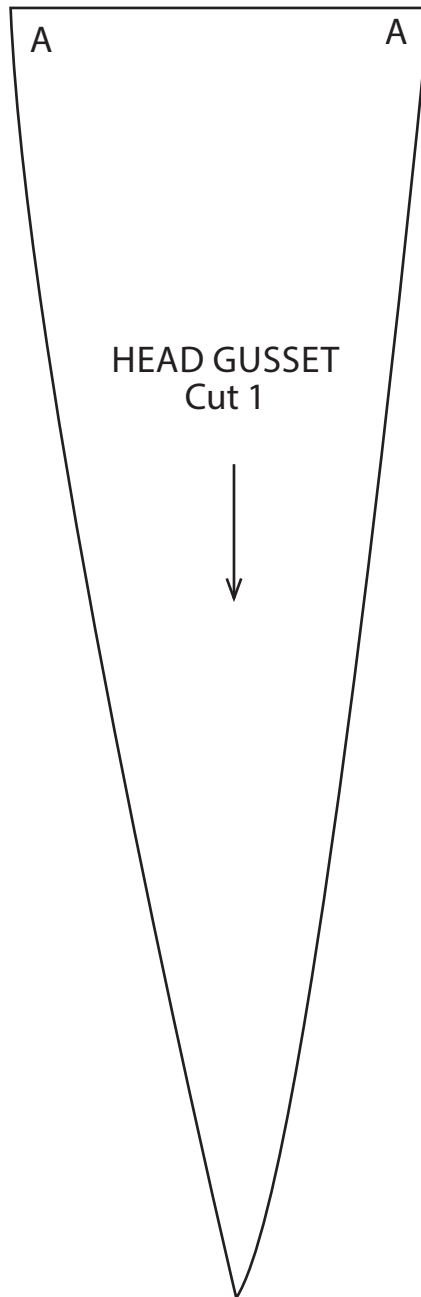

Thank you for making these projects from *Simply Sewing*. The copyright for these templates belongs to the designer of the project. They work hard to create projects for you to enjoy, so please don't re-sell or distribute their work without permission. Please do not make any part of the templates or instructions available to others through your website or a third party, or copy it multiple times without our permission. Copyright law protects creative work and unauthorised copying is illegal. We appreciate your help.

TEMPLATES

PIGLET TOY

PAGE 72
ACTUAL SIZE

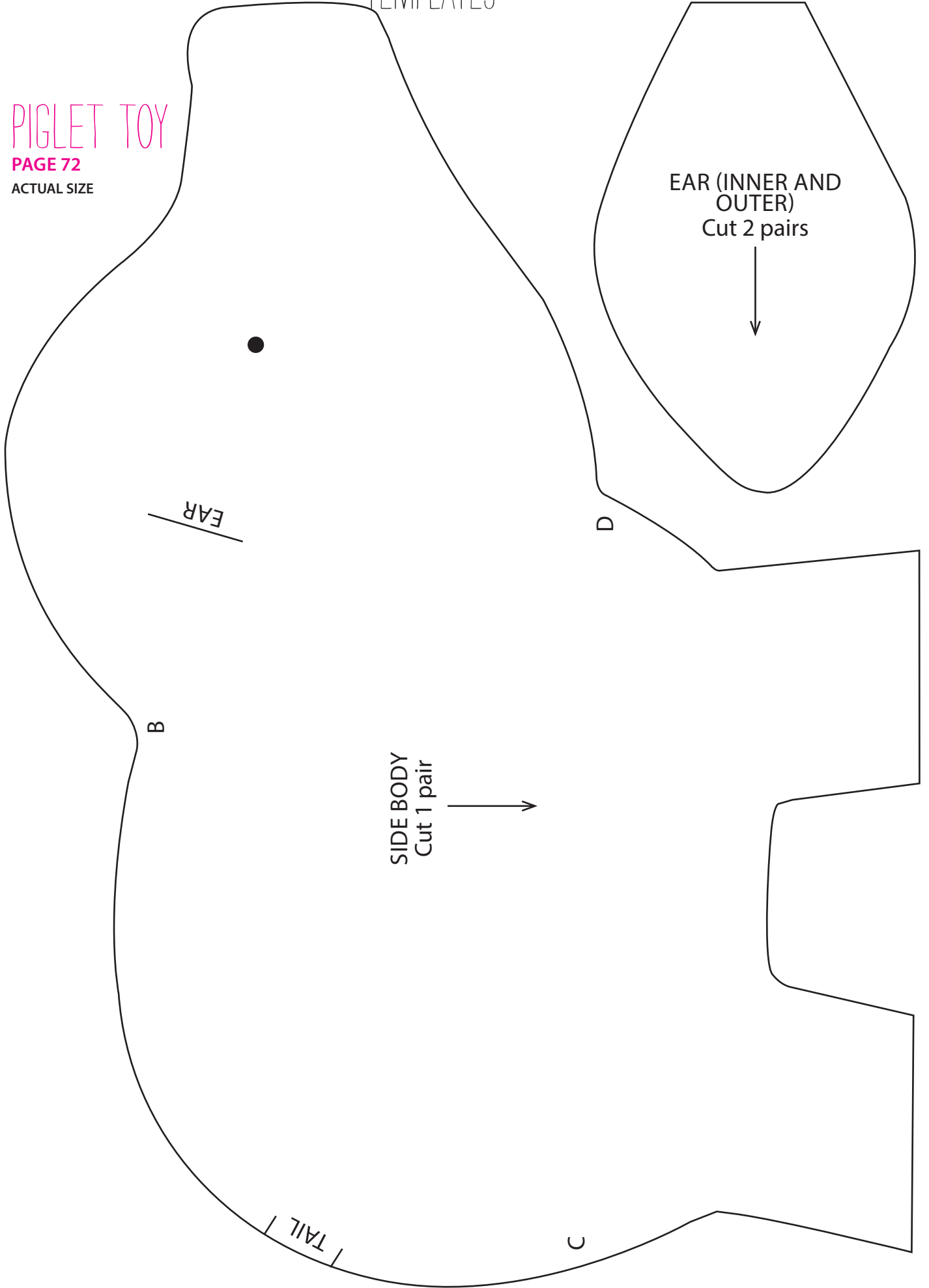

EAR (INNER AND
OUTER)
Cut 2 pairs



SIDE BODY
Cut 1 pair



HOUSE BAGS

PAGE 53

ACTUAL SIZE

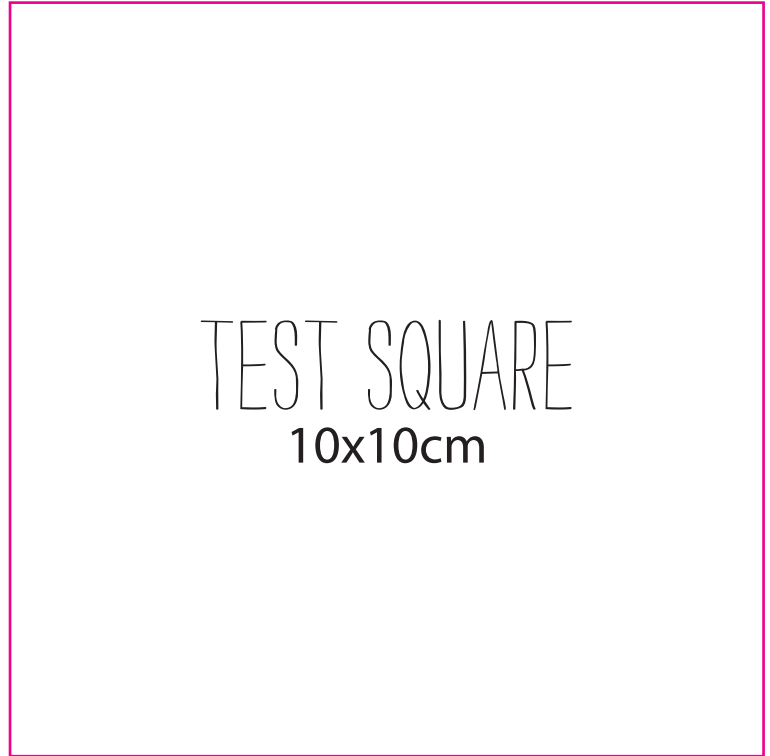
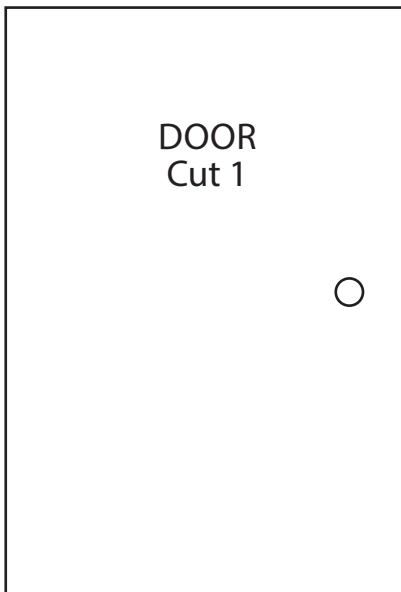
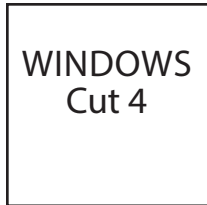
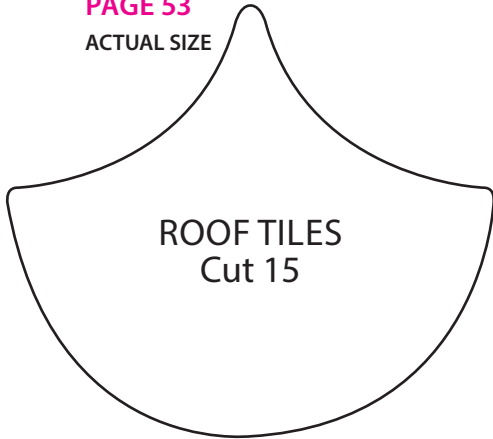

EGG COSY

PAGE 40

ACTUAL SIZE

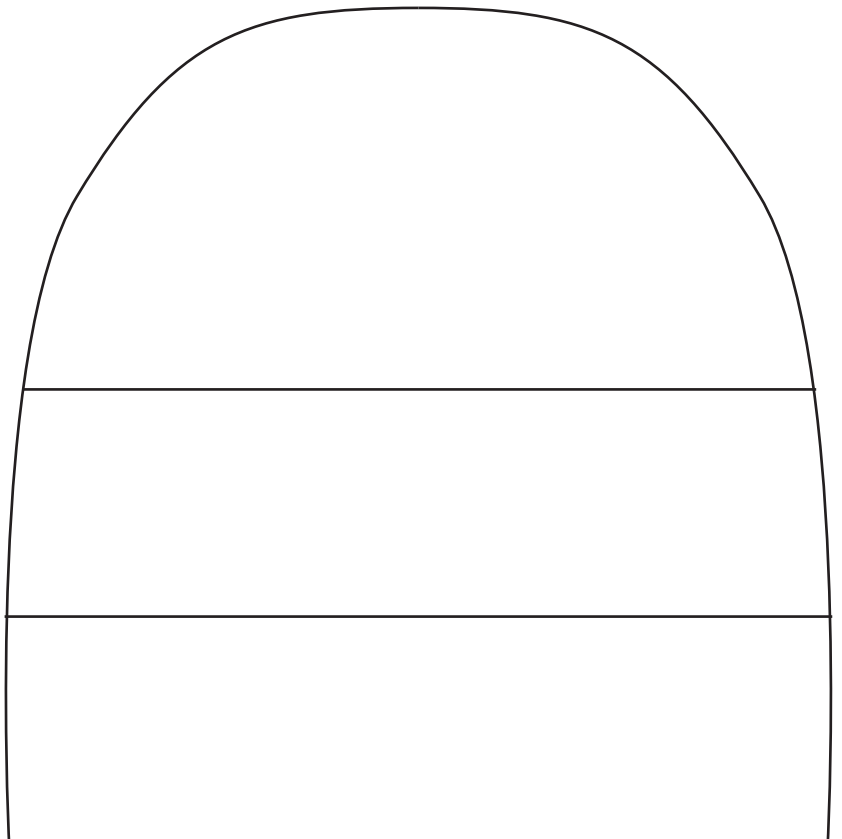



RISE AND SHINE
BANNER

PAGE 38
ACTUAL SIZE

Rise

and

shine



POT HOLDER

PAGE 36

ACTUAL SIZE

HANGING LOOP

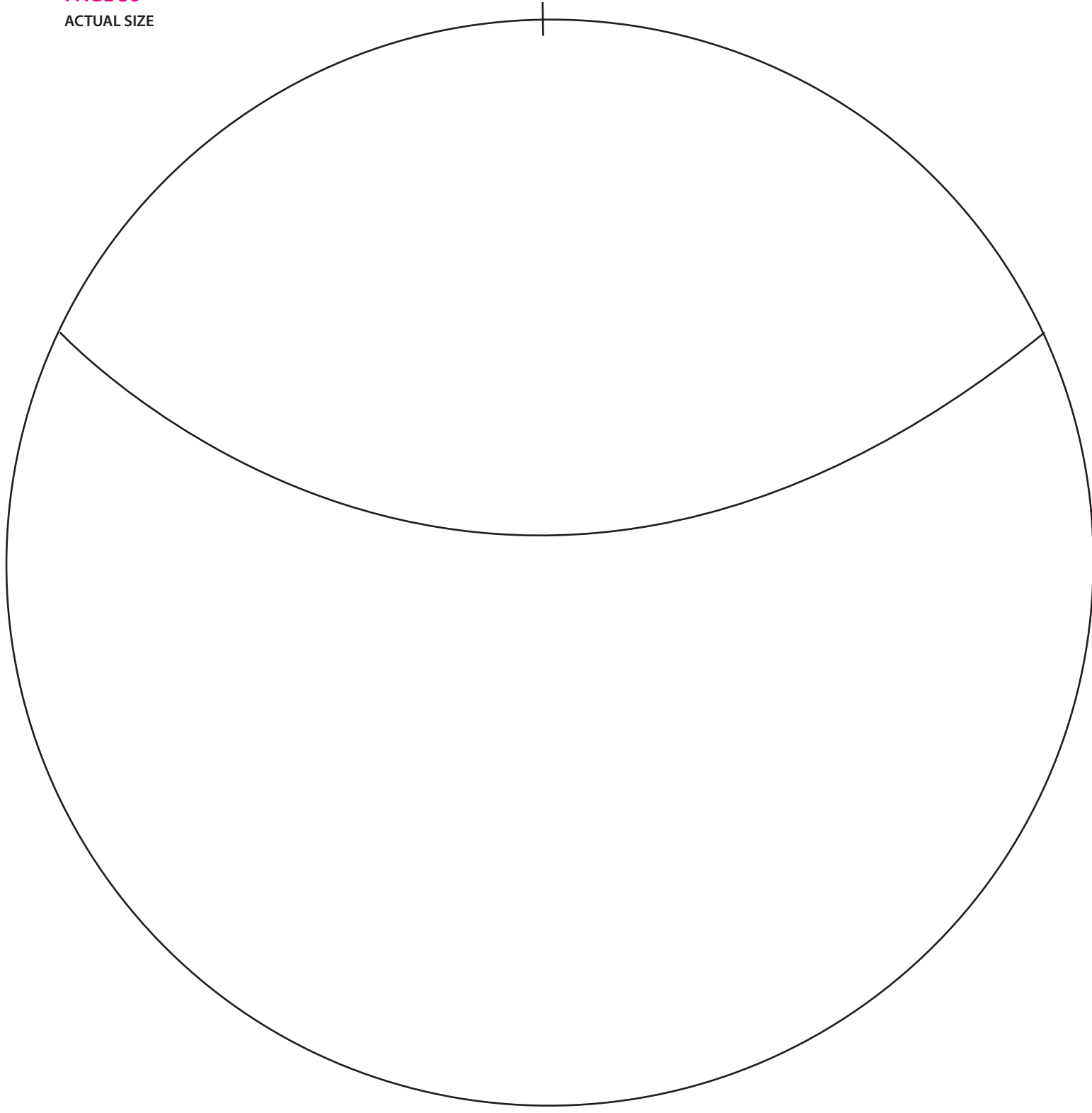

FACE MASK

PAGE 79

ACTUAL SIZE

4 SIZES:

- S BABIES / CHILDREN (SMALL)
- M CHILDREN (NORMAL) / ADULTS (SMALL)
- L ADULTS (NORMAL)
- XL ADULTS (LARGE)

Fadenlauf = grain line

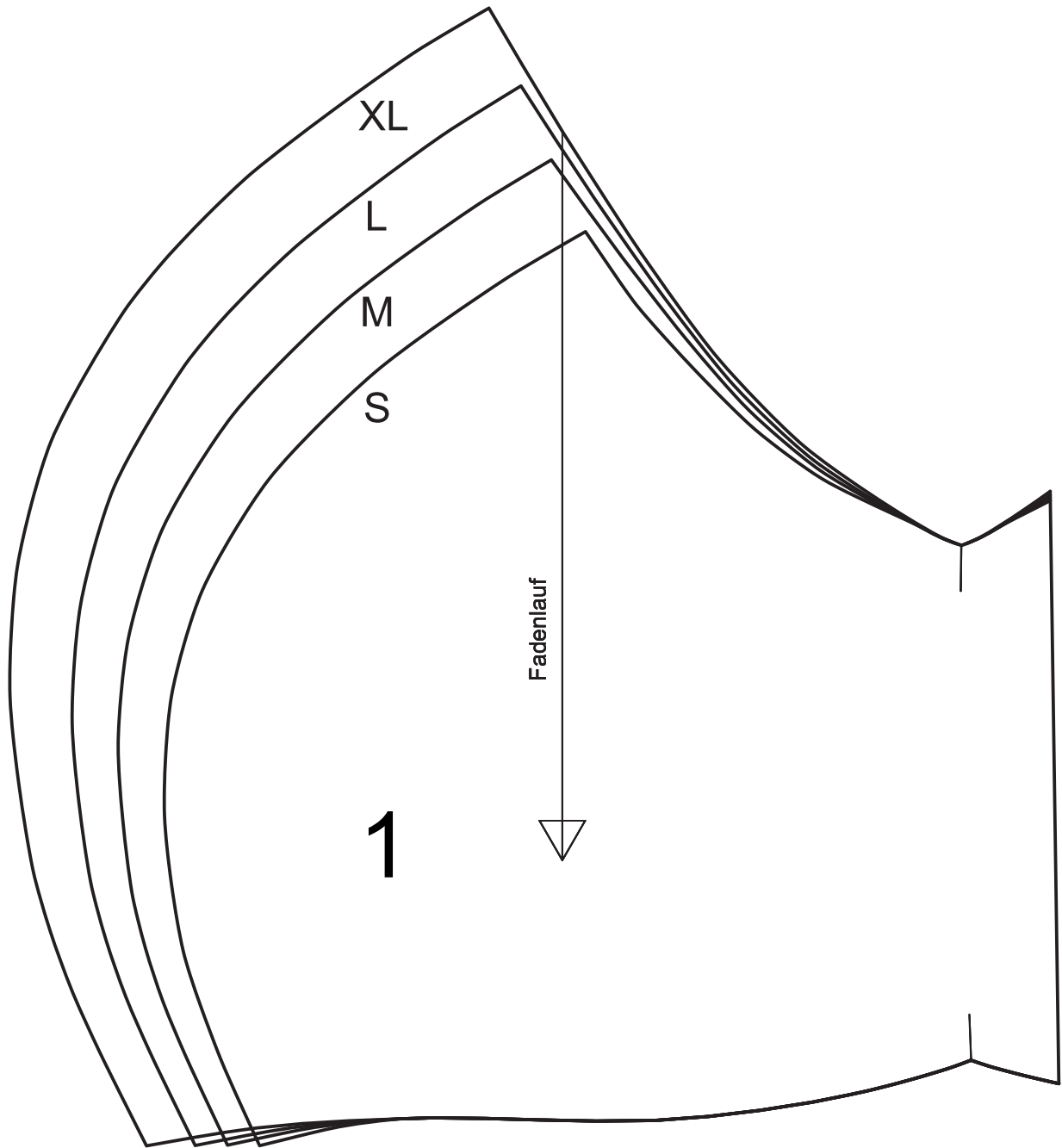

TEMPLATES

FACE MASK

PAGE 79

ACTUAL SIZE

4 SIZES:

S	BABIES / CHILDREN (SMALL)
M	CHILDREN (NORMAL) / ADULTS (SMALL)
L	ADULTS (NORMAL)
XL	ADULTS (LARGE)

Fadenlauf = grain line

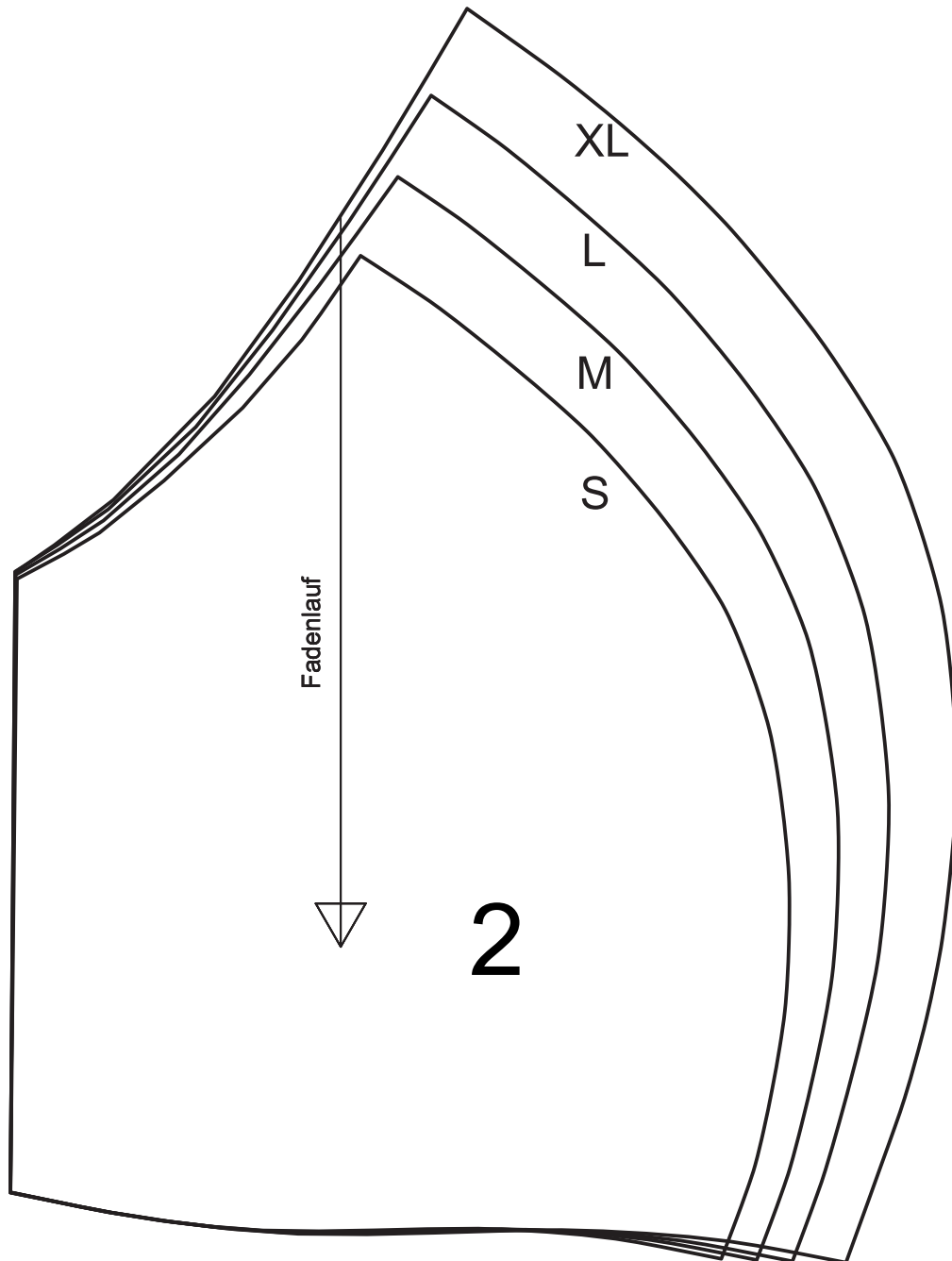

TRY
3 ISSUES
FOR £5!



LEARN HOW
Machine tension
troubleshooting

2020 TRENDS
DENIM
TOP 10 EXPERT TIPS
+ PATTERN ROUND-UP



PERFECT FIT

12 garments, homewares and gifts to make you smile

+PLUS: Lion cushion • Sunglasses case • Kid's playroom • Sewing podcasts



*Sewing gifts
with every
issue!*

Simply Sewing is the perfect magazine for the modern sewist! Simple-to-follow projects mean you can get started straight away, using the fabulous sewing gifts with every issue. Already whipping up home-sewn makes? Be inspired by expert tricks and tips, in-depth technical features and profiles of amazing designers. *Simply Sewing* is a new approach to dressmaking and home sewing.

SUBSCRIBE TODAY: TRY 3 ISSUES FOR £5!

www.buysubscriptions.com/SWGTHA

or call 03330 162 149 & quote code SWGTHA

[facebook.com/simplysewingmagazine](https://www.facebook.com/simplysewingmagazine) twitter.com/simplysewing [pinterest.com/simplysewingmag](https://www.pinterest.com/simplysewingmag) [instagram.com/simplysewingmag](https://www.instagram.com/simplysewingmag)

www.gathered.how/simplysewing

Terms and conditions: This introductory offer is for new UK Direct Debit subscribers only. After your first 3 issues, your subscription will continue at £17.99 every 3 issues. If you cancel within 2 weeks of receiving your penultimate issue you will pay no more than the £5 shown. All prices include home delivery. Full details of the Direct Debit guarantee are available on request. Prices correct at point of print and subject to change. Offer ends 31st December 2020. We reserve the right to reject or cancel any application for a trial subscription offer if you have previously benefited from a trial offer for the same magazine in the last 12 months or had three or more trial subscriptions to any magazine in the Immediate Media portfolio. UK calls will cost the same as other standard fixed line numbers (starting 01 or 02) and are included as part of any inclusive or free minutes allowances (if offered by your phone tariff). Outside of free call packages call charges from mobile phones will cost between 3p and 55p per minute. Lines are open Mon to Fri 8am – 6pm and Sat 9am – 1pm.