

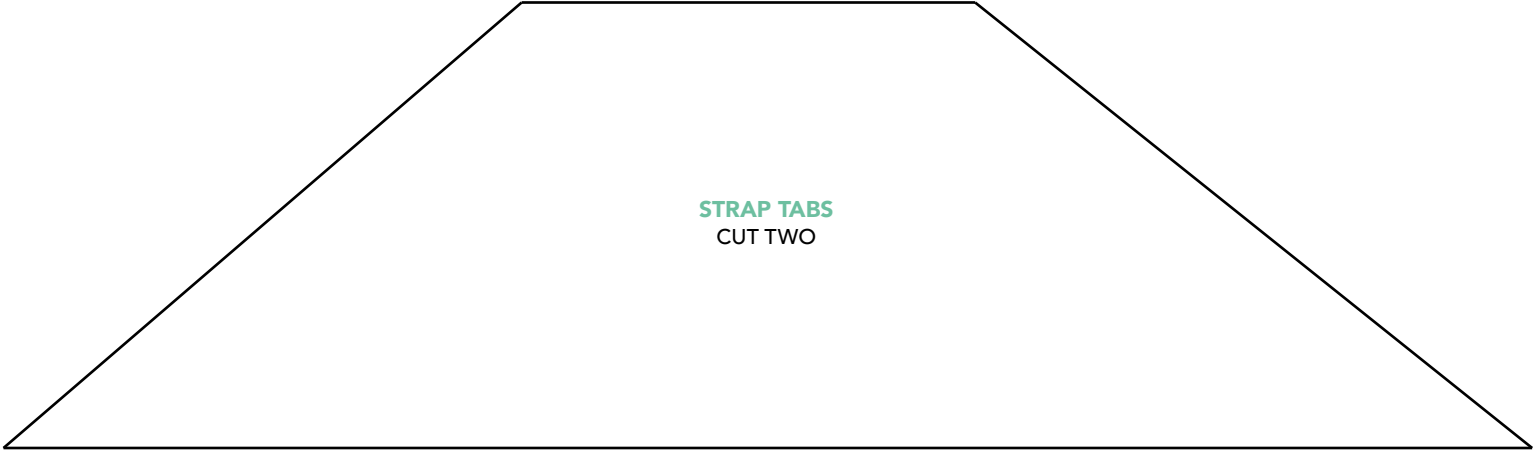

TEMPLATES

ISSUE 134

Thank you for making this project from *Mollie Makes*. We have requested specific permission from designers so that you can recreate and sell selected projects from this issue on the following conditions. Just look for this icon.  You can individually hand-make as many as you wish of our labelled projects, to sell either for yourself, your local event or to raise money for charity. You cannot sell in shops (online or otherwise) and you cannot go into mass production, which means you cannot manufacture in large quantities, especially by machine. Selling photocopies of any part of this magazine, its kits or supplements is prohibited. We don't mind if you make a copy of the templates for a friend but please do not make any part of the templates or instructions available to others through your website or a third party website, or copy it multiple times without our permission. Please respect one another's copyright.

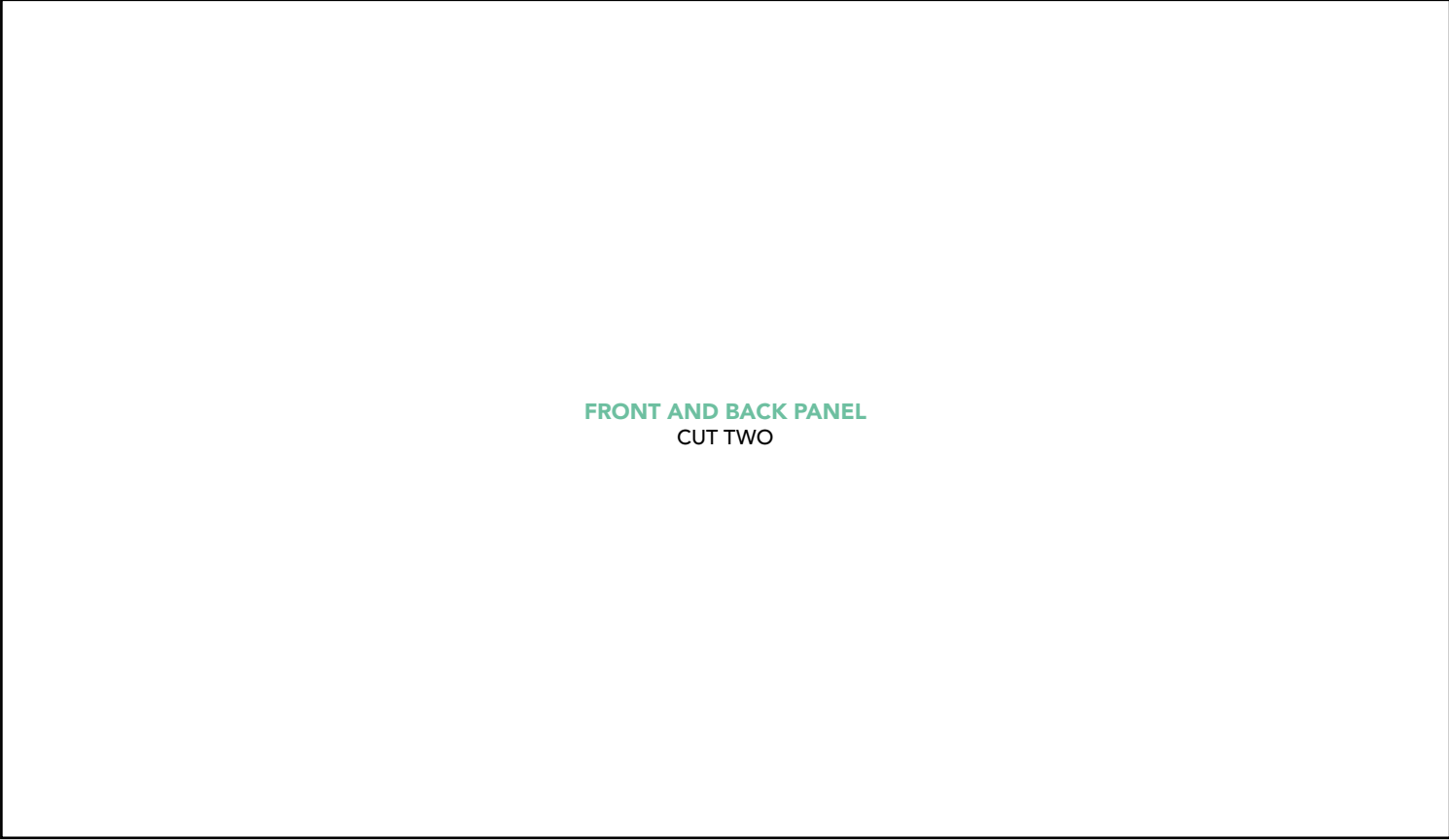

Thank you for making this project from *Mollie Makes*. We have requested specific permission from designers so that you can recreate and sell selected projects from this issue on the following conditions. Just look for this icon.  You can individually hand-make as many as you wish of our labelled projects, to sell either for yourself, your local event or to raise money for charity. You cannot sell in shops (online or otherwise) and you cannot go into mass production, which means you cannot manufacture in large quantities, especially by machine. Selling photocopies of any part of this magazine, its kits or supplements is prohibited. We don't mind if you make a copy of the templates for a friend but please do not make any part of the templates or instructions available to others through your website or a third party website, or copy it multiple times without our permission. Please respect one another's copyright.

POCKET
CUT ONE IN CONTRAST

**BOTTOM
PANEL**
CUT ONE

**ZIP
PANEL**
CUT TWO
ON FOLD

FOLD

AUTUMN WREATH

BY HANNAH KILBY

PAGE 14

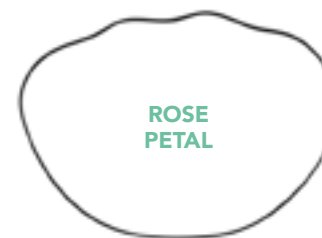
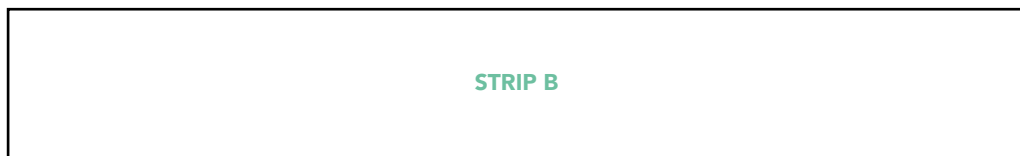
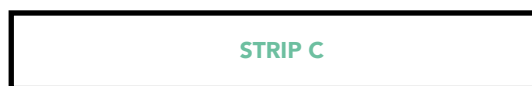
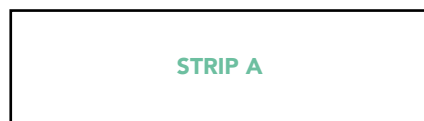
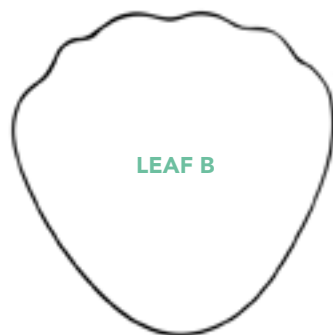
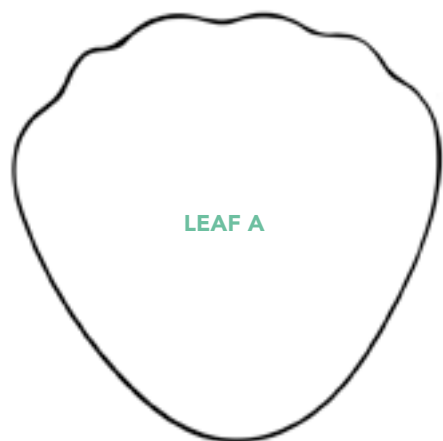

PUNCH NEEDLE SLIPPERS

BY ZOE BATEMAN

PAGE 30

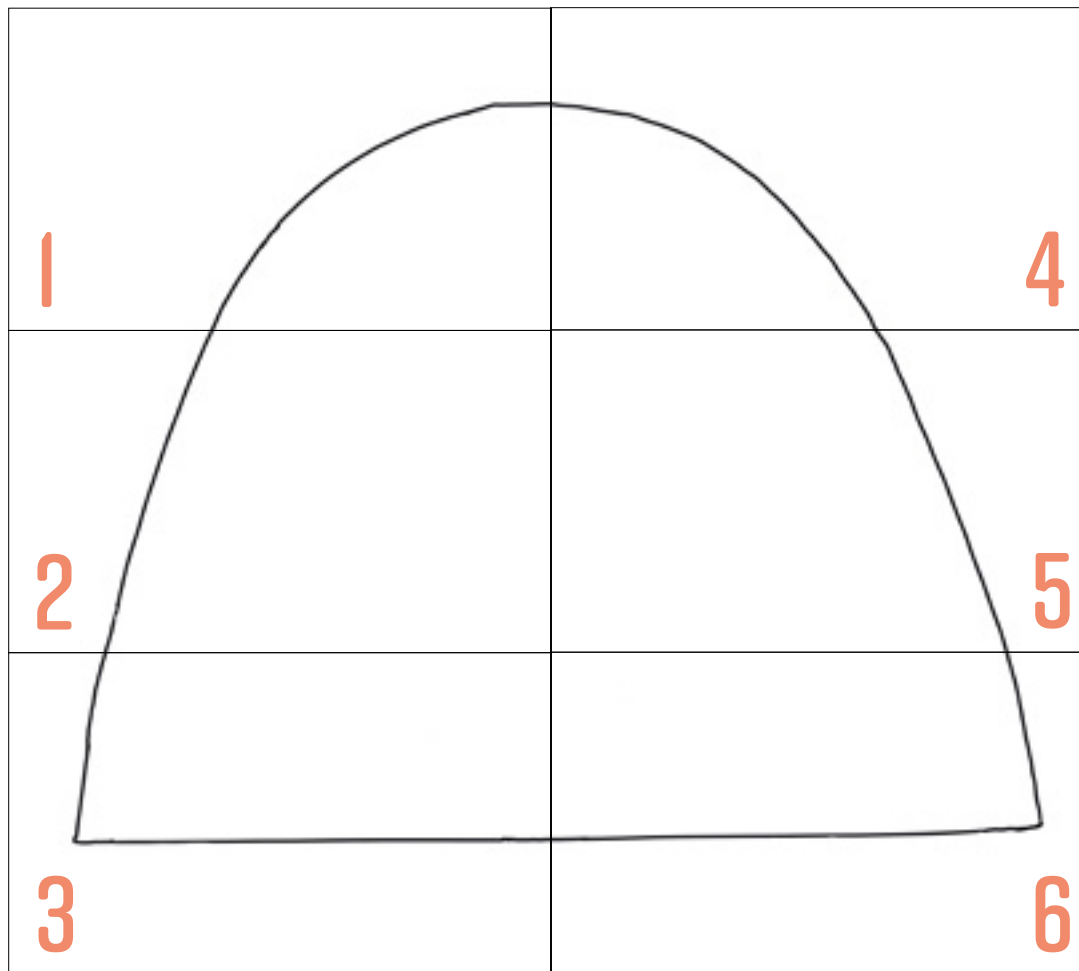

Thank you for making this project from *Mollie Makes*. We have requested specific permission from designers so that you can recreate and sell selected projects from this issue on the following conditions. Just look for this icon.  You can individually hand-make as many as you wish of our labelled projects, to sell either for yourself, your local event or to raise money for charity. You cannot sell in shops (online or otherwise) and you cannot go into mass production, which means you cannot manufacture in large quantities, especially by machine. Selling photocopies of any part of this magazine, its kits or supplements is prohibited. We don't mind if you make a copy of the templates for a friend but please do not make any part of the templates or instructions available to others through your website or a third party website, or copy it multiple times without our permission. Please respect one another's copyright.

CUT ALONG DOTTED LINE TO ASSEMBLE PATTERN

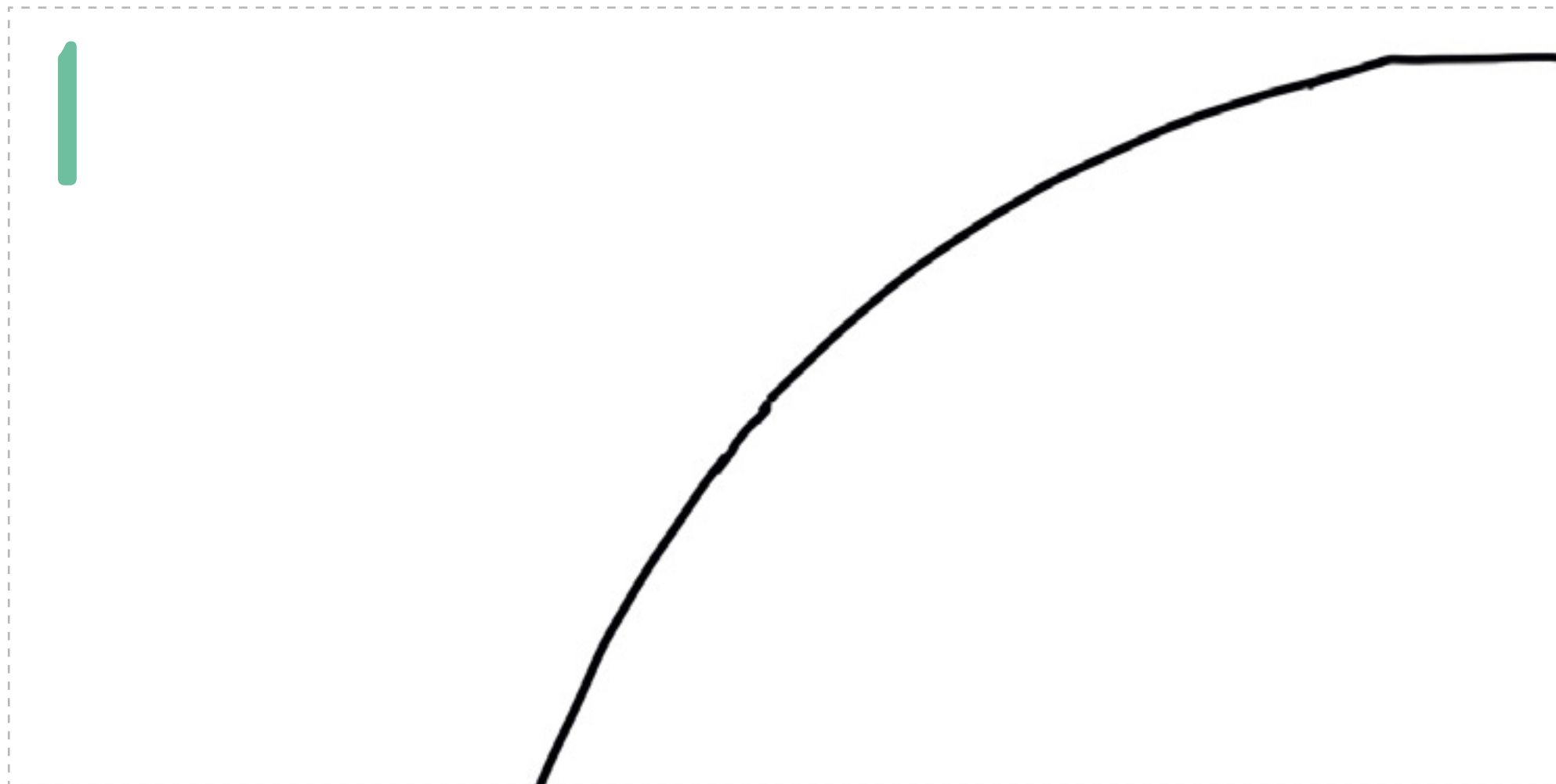

JOIN TO 2

JOIN TO 4

Thank you for making this project from *Mollie Makes*. We have requested specific permission from designers so that you can recreate and sell selected projects from this issue on the following conditions. Just look for this icon.  You can individually hand-make as many as you wish of our labelled projects, to sell either for yourself, your local event or to raise money for charity. You cannot sell in shops (online or otherwise) and you cannot go into mass production, which means you cannot manufacture in large quantities, especially by machine. Selling photocopies of any part of this magazine, its kits or supplements is prohibited. We don't mind if you make a copy of the templates for a friend but please do not make any part of the templates or instructions available to others through your website or a third party website, or copy it multiple times without our permission. Please respect one another's copyright.

CUT ALONG DOTTED LINE TO ASSEMBLE PATTERN

JOIN TO 1

2

JOIN TO 5

JOIN TO 3

Thank you for making this project from *Mollie Makes*. We have requested specific permission from designers so that you can recreate and sell selected projects from this issue on the following conditions. Just look for this icon.  You can individually hand-make as many as you wish of our labelled projects, to sell either for yourself, your local event or to raise money for charity. You cannot sell in shops (online or otherwise) and you cannot go into mass production, which means you cannot manufacture in large quantities, especially by machine. Selling photocopies of any part of this magazine, its kits or supplements is prohibited. We don't mind if you make a copy of the templates for a friend but please do not make any part of the templates or instructions available to others through your website or a third party website, or copy it multiple times without our permission. Please respect one another's copyright.

CUT ALONG DOTTED LINE TO ASSEMBLE PATTERN

JOIN TO 2

3

JOIN TO 6

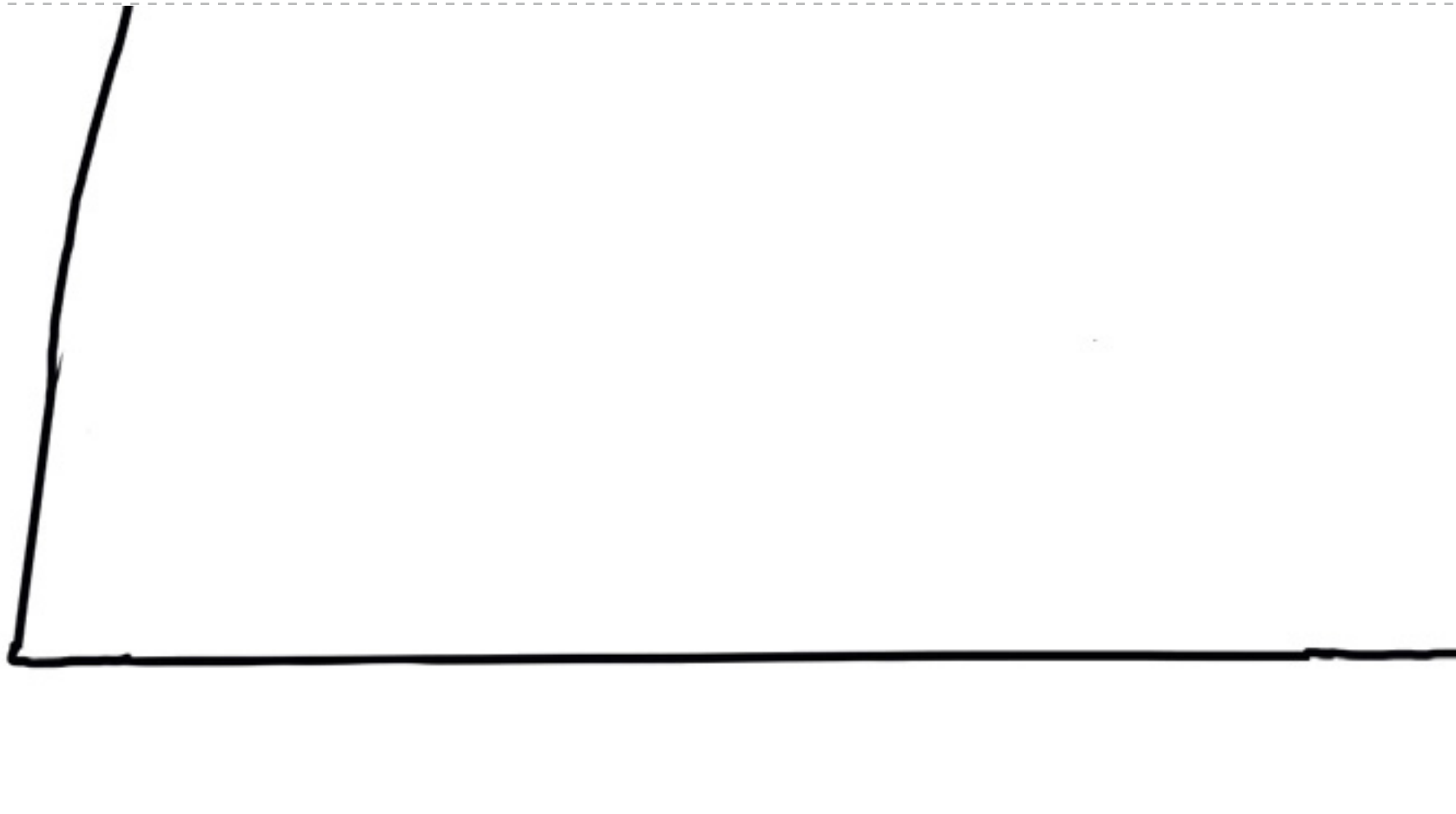

Thank you for making this project from *Mollie Makes*. We have requested specific permission from designers so that you can recreate and sell selected projects from this issue on the following conditions. Just look for this icon.  You can individually hand-make as many as you wish of our labelled projects, to sell either for yourself, your local event or to raise money for charity. You cannot sell in shops (online or otherwise) and you cannot go into mass production, which means you cannot manufacture in large quantities, especially by machine. Selling photocopies of any part of this magazine, its kits or supplements is prohibited. We don't mind if you make a copy of the templates for a friend but please do not make any part of the templates or instructions available to others through your website or a third party website, or copy it multiple times without our permission. Please respect one another's copyright.

CUT ALONG DOTTED LINE TO ASSEMBLE PATTERN

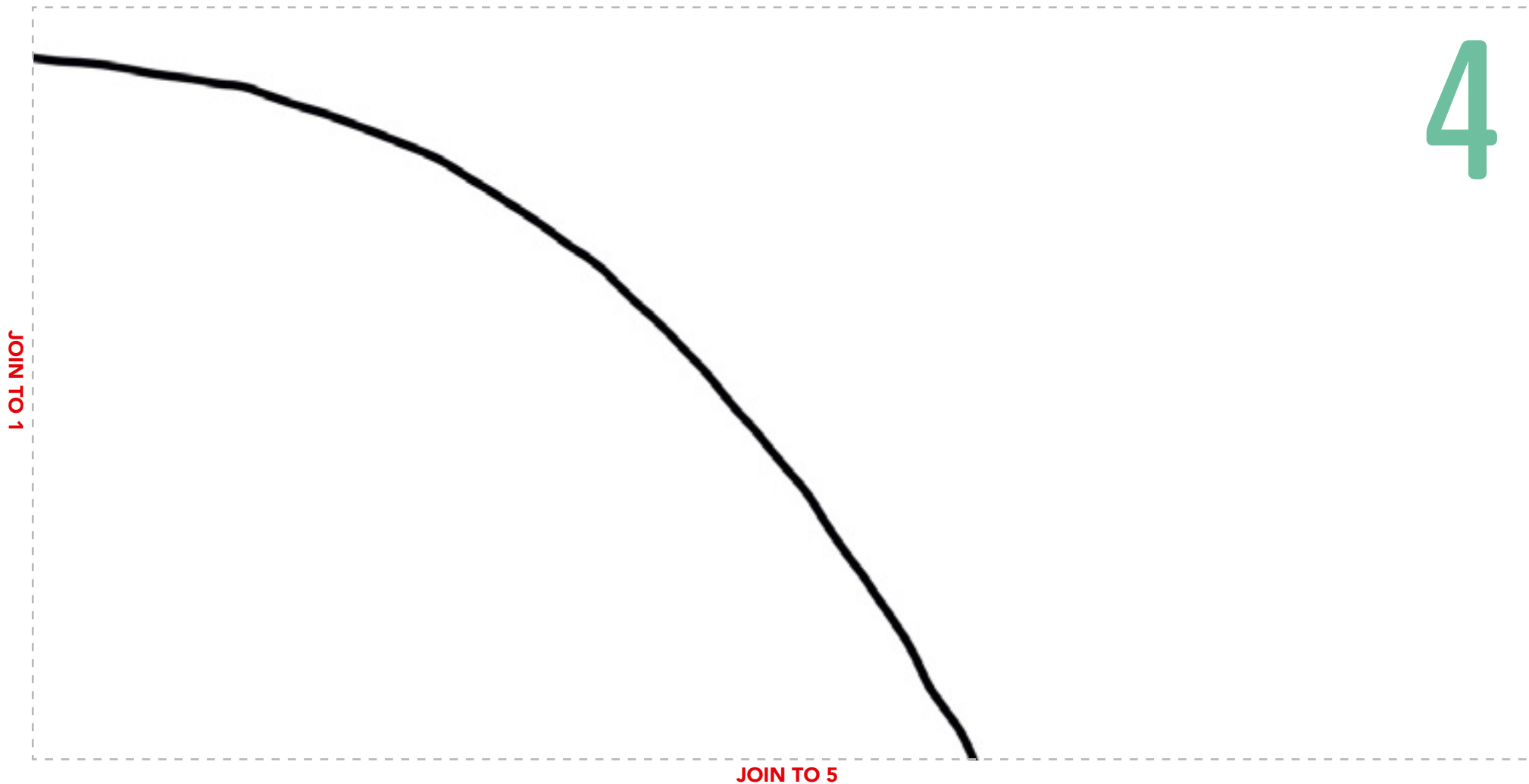

Thank you for making this project from *Mollie Makes*. We have requested specific permission from designers so that you can recreate and sell selected projects from this issue on the following conditions. Just look for this icon.  You can individually hand-make as many as you wish of our labelled projects, to sell either for yourself, your local event or to raise money for charity. You cannot sell in shops (online or otherwise) and you cannot go into mass production, which means you cannot manufacture in large quantities, especially by machine. Selling photocopies of any part of this magazine, its kits or supplements is prohibited. We don't mind if you make a copy of the templates for a friend but please do not make any part of the templates or instructions available to others through your website or a third party website, or copy it multiple times without our permission. Please respect one another's copyright.

CUT ALONG DOTTED LINE TO ASSEMBLE PATTERN

JOIN TO 4

5

JOIN TO 2

JOIN TO 6

Thank you for making this project from *Mollie Makes*. We have requested specific permission from designers so that you can recreate and sell selected projects from this issue on the following conditions. Just look for this icon.  You can individually hand-make as many as you wish of our labelled projects, to sell either for yourself, your local event or to raise money for charity. You cannot sell in shops (online or otherwise) and you cannot go into mass production, which means you cannot manufacture in large quantities, especially by machine. Selling photocopies of any part of this magazine, its kits or supplements is prohibited. We don't mind if you make a copy of the templates for a friend but please do not make any part of the templates or instructions available to others through your website or a third party website, or copy it multiple times without our permission. Please respect one another's copyright.

CUT ALONG DOTTED LINE TO ASSEMBLE PATTERN

JOIN TO 5

JOIN TO 3

6



Thank you for making this project from *Mollie Makes*. We have requested specific permission from designers so that you can recreate and sell selected projects from this issue on the following conditions. Just look for this icon.  You can individually hand-make as many as you wish of our labelled projects, to sell either for yourself, your local event or to raise money for charity. You cannot sell in shops (online or otherwise) and you cannot go into mass production, which means you cannot manufacture in large quantities, especially by machine. Selling photocopies of any part of this magazine, its kits or supplements is prohibited. We don't mind if you make a copy of the templates for a friend but please do not make any part of the templates or instructions available to others through your website or a third party website, or copy it multiple times without our permission. Please respect one another's copyright.