

THE STANWAY T-SHIRT

HOW TO PRINT THIS PATTERN

Print out this 30-page PDF on to A4 paper. Trim away the shaded border from each page and position the pages as below to assemble the pattern...

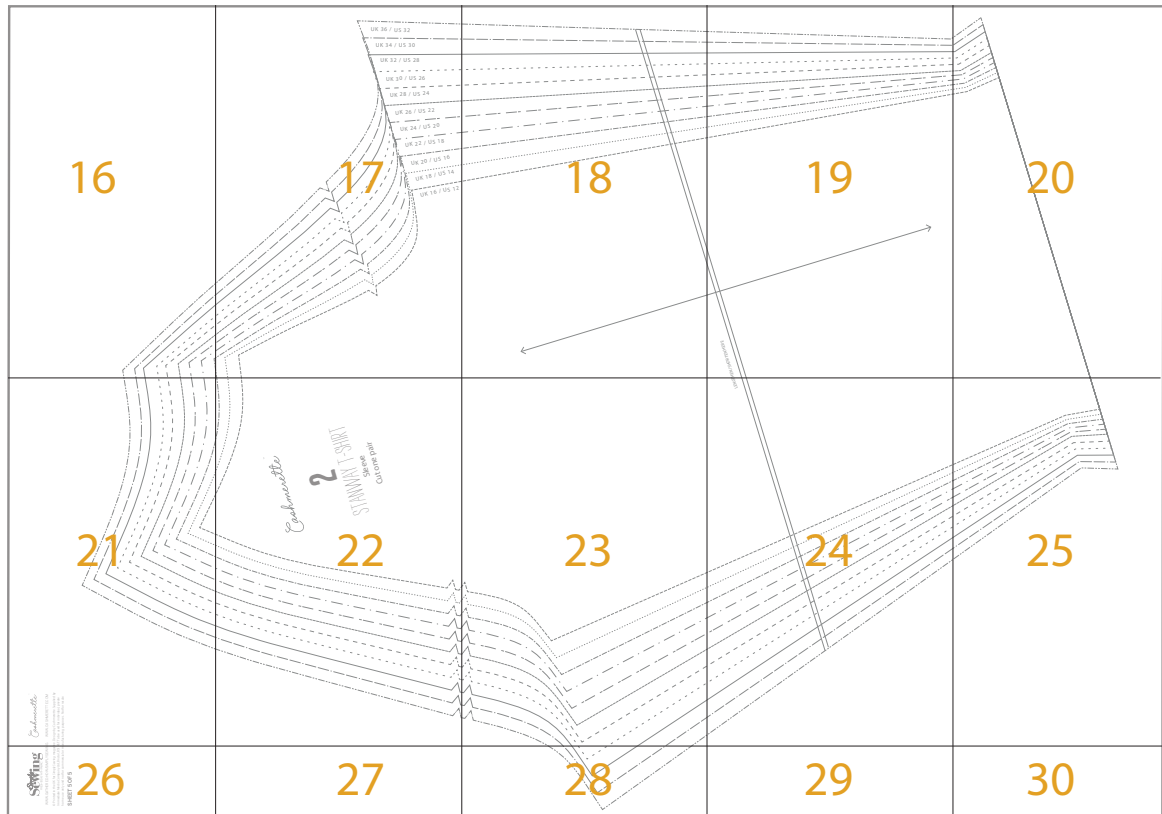
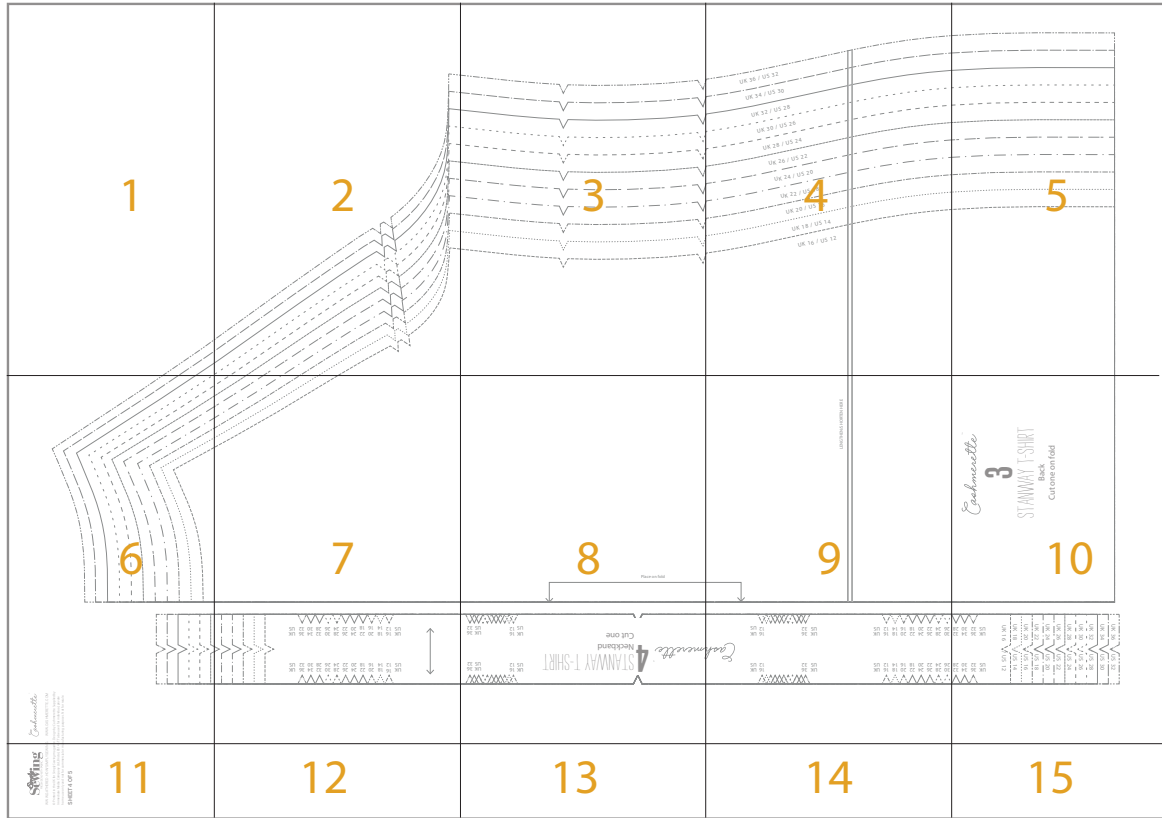

TEST SQUARE
10x10cm

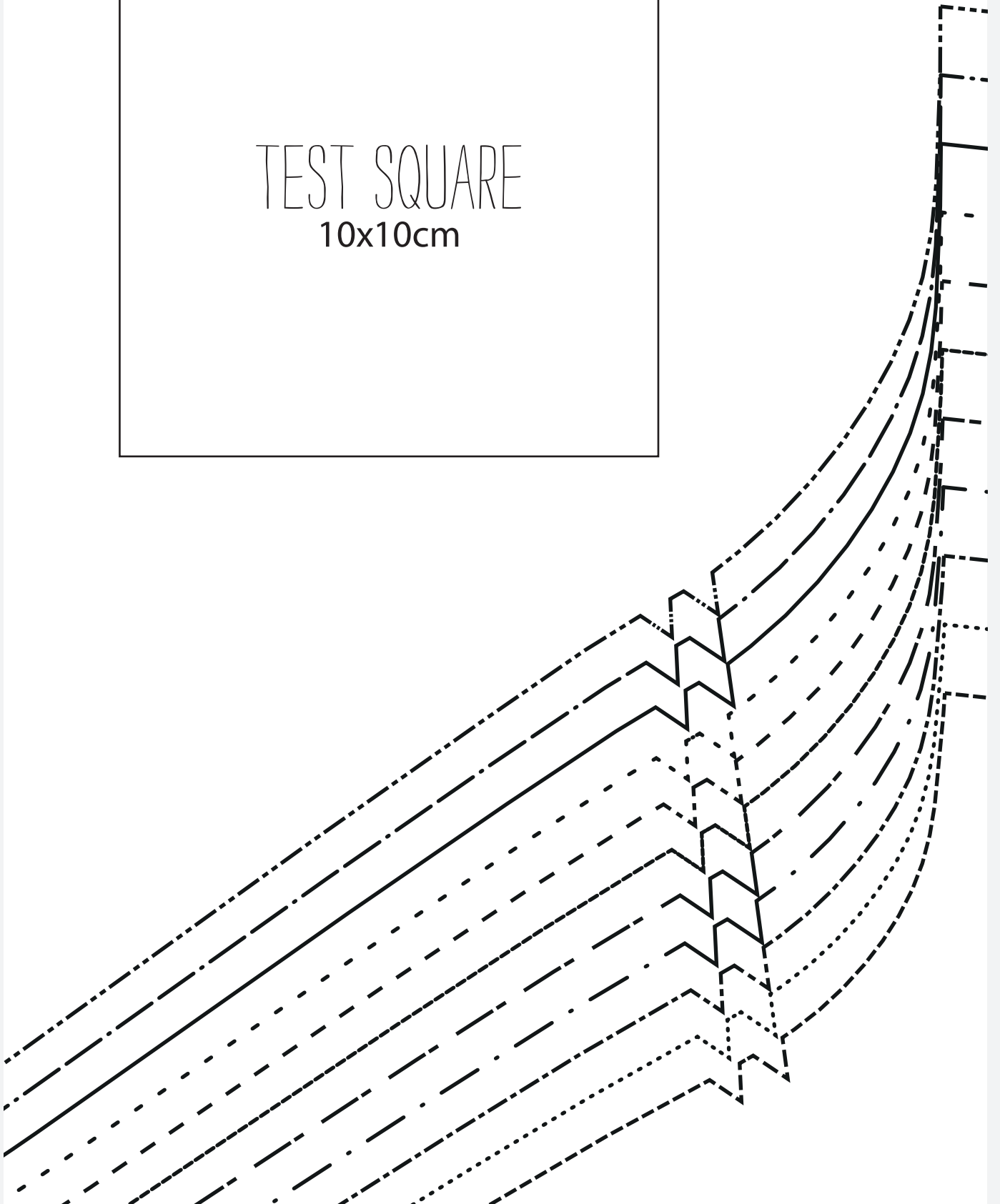

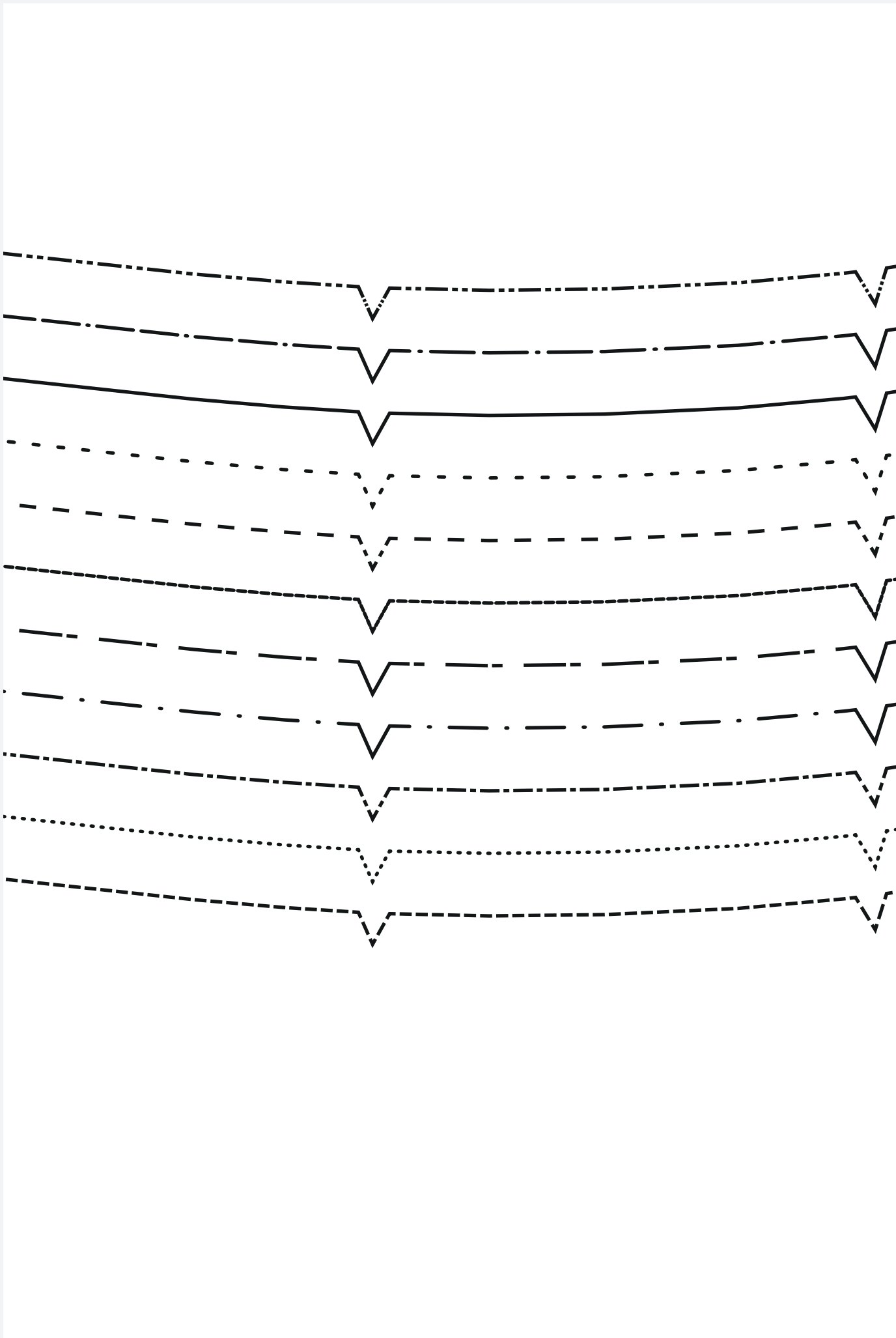

UK 36 / US 32

UK 34 / US 30

UK 32 / US 28

UK 30 / US 26

UK 28 / US 24

UK 26 / US 22

UK 24 / US 20

UK 22 / US 18

UK 20 / US 16

UK 18 / US 14

UK 16 / US 12

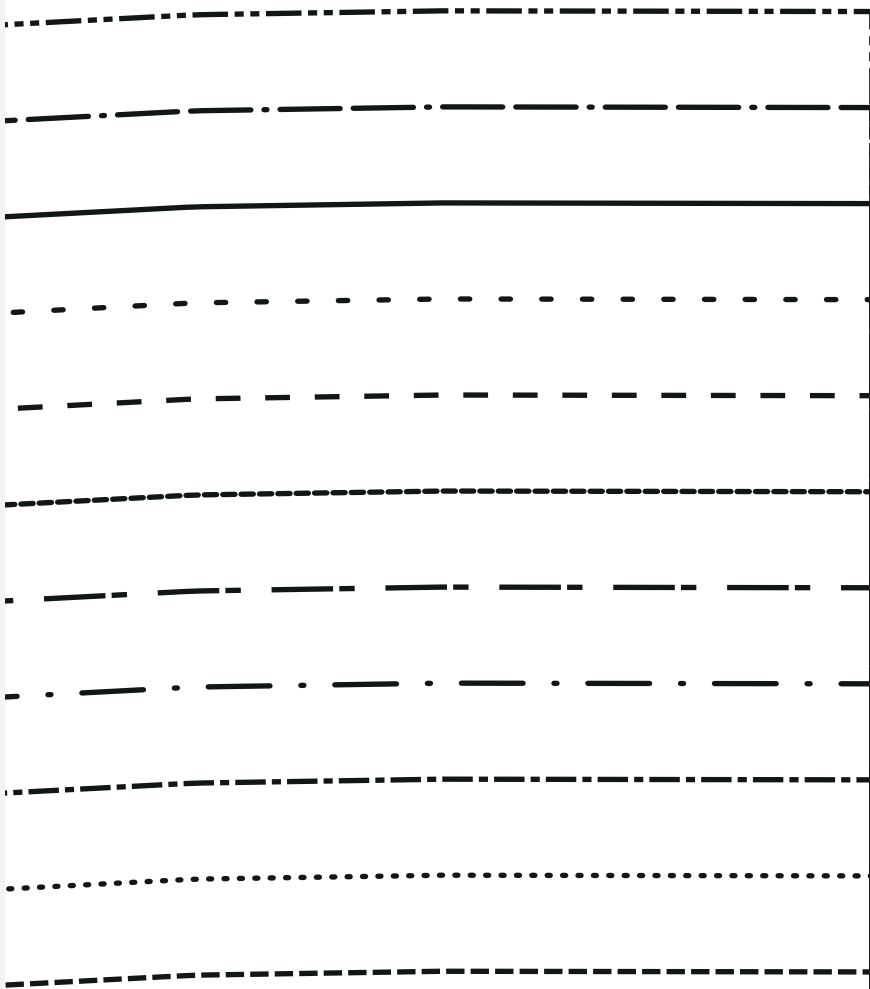

Cashmerette

G WWW.CASHMERETTE.COM

ne. Design by Cashmerette. Supplied by
IST. To be used for individual, private
manufacturing purposes. Not for resale.

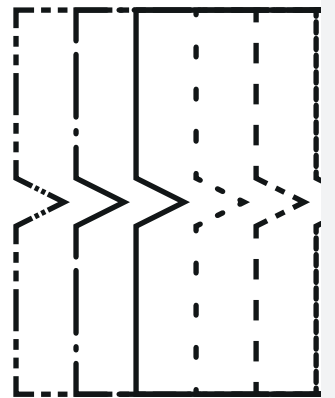
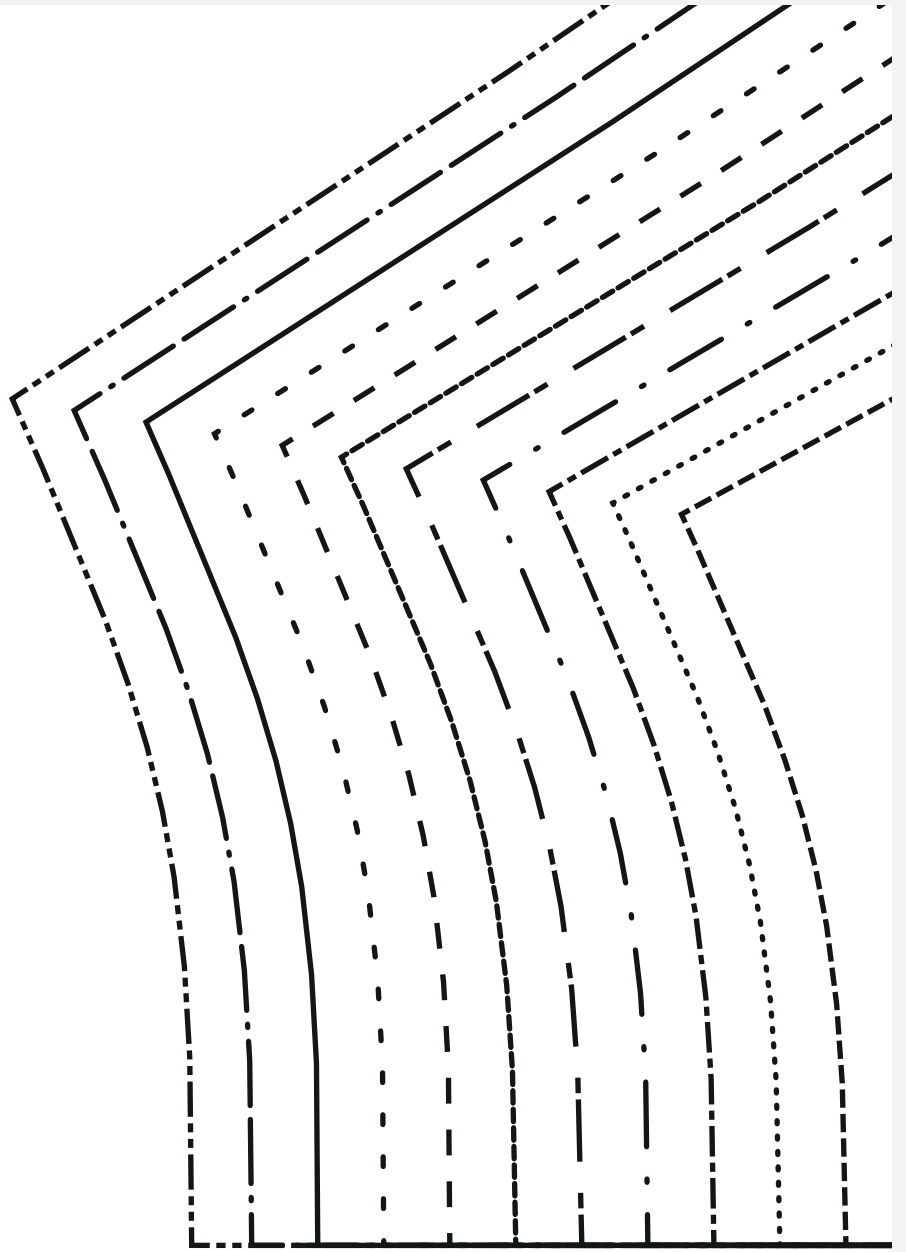

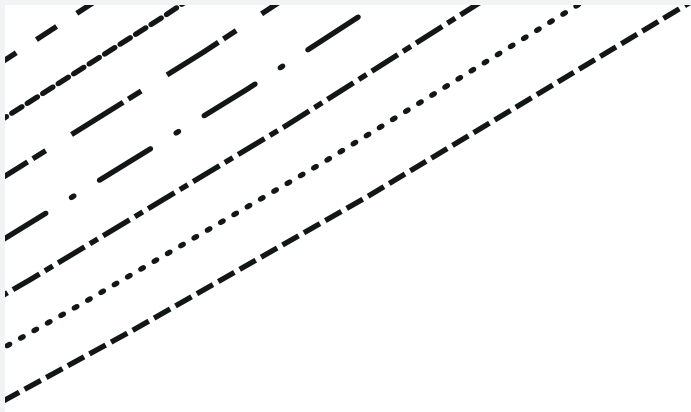

UK 16 18 20 22 24 26 28 30 32 34 36 UK
US 12 14 16 18 20 22 24 26 28 30 32 US

Place on fold



4 *innoselle*TM
STANWAY T-SHIRT
Neckband
Cut one

UK 16 US 12
UK 36 US 32

UK 16 US 12
UK 36 US 32

LENGTHEN/SHORTEN HERE



UK 36 US 32
16 UK 12 US

UK 16 US 12
18 20 22 24 26 28 30 32
16 18 20 22 24 26 28 30 32
14 16 18 20 22 24 26 28

Coat

UK 36 US 32
16 UK 12 US

UK 16 US 12
18 20 22 24 26 28 30 32
16 18 20 22 24 26 28 30 32
14 16 18 20 22 24 26 28

Cashmerette™

3

STANWAY T-SHIRT

Back

Cut one on fold

UK 36	US 32
UK 34	US 30
UK 32	US 28
UK 30	US 26
UK 28	US 24
UK 26	US 22
UK 24	US 20
UK 22	US 18
UK 20	US 16
UK 18	US 14
UK 16	US 12

Simply
Sewing
FRESH IDEAS WITH FABRIC

WWW.GATHERED.HOW/SIMPLYSEWIN

© Printed in the UK for *Simply Sewing* magazine
Immediate Media Company Ltd, Bristol, BS1 4
home use only and not for commercial or ma

SHEET 4 OF 5

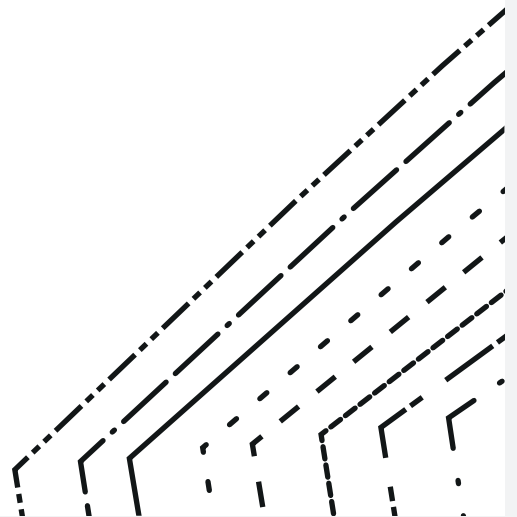

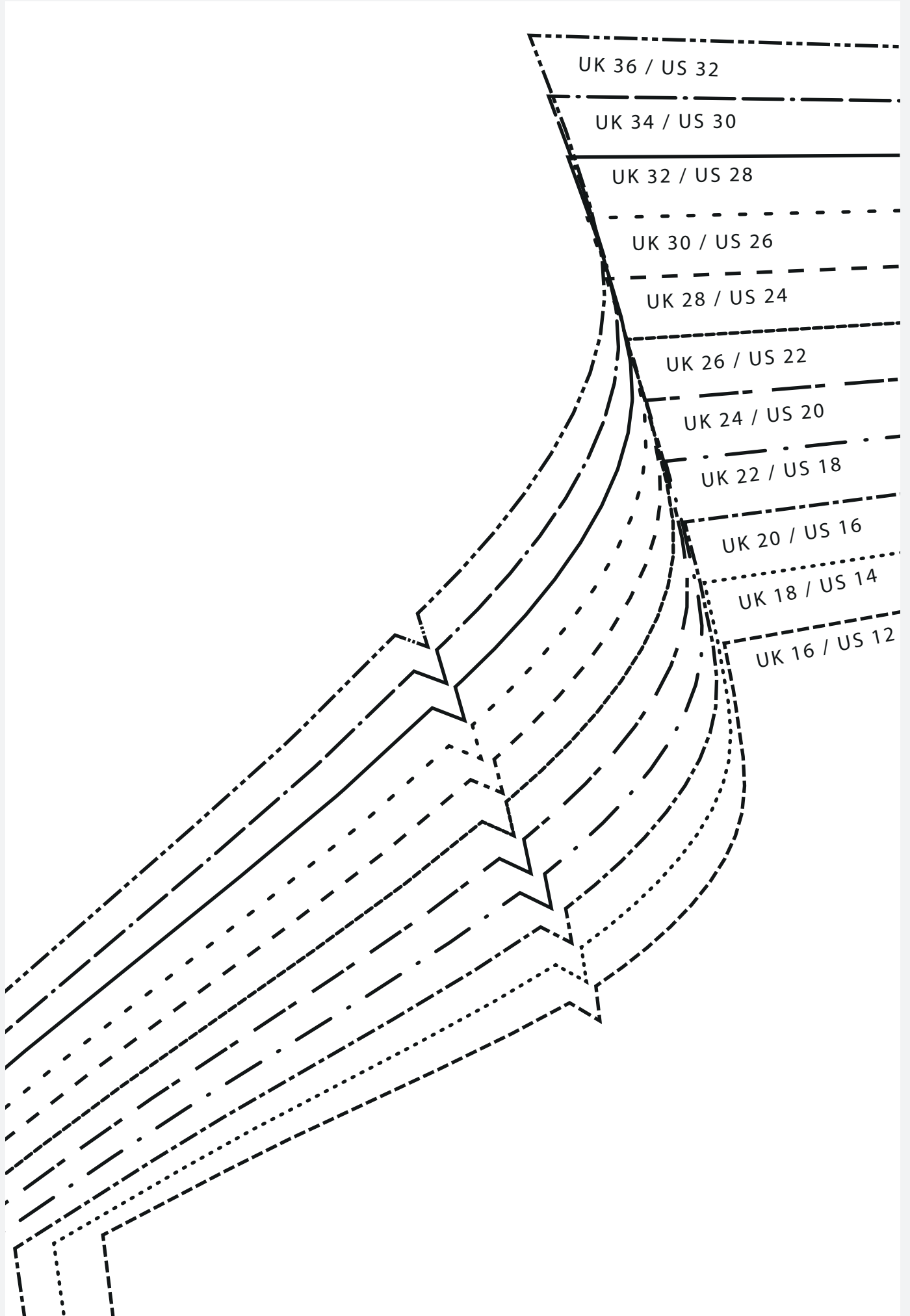

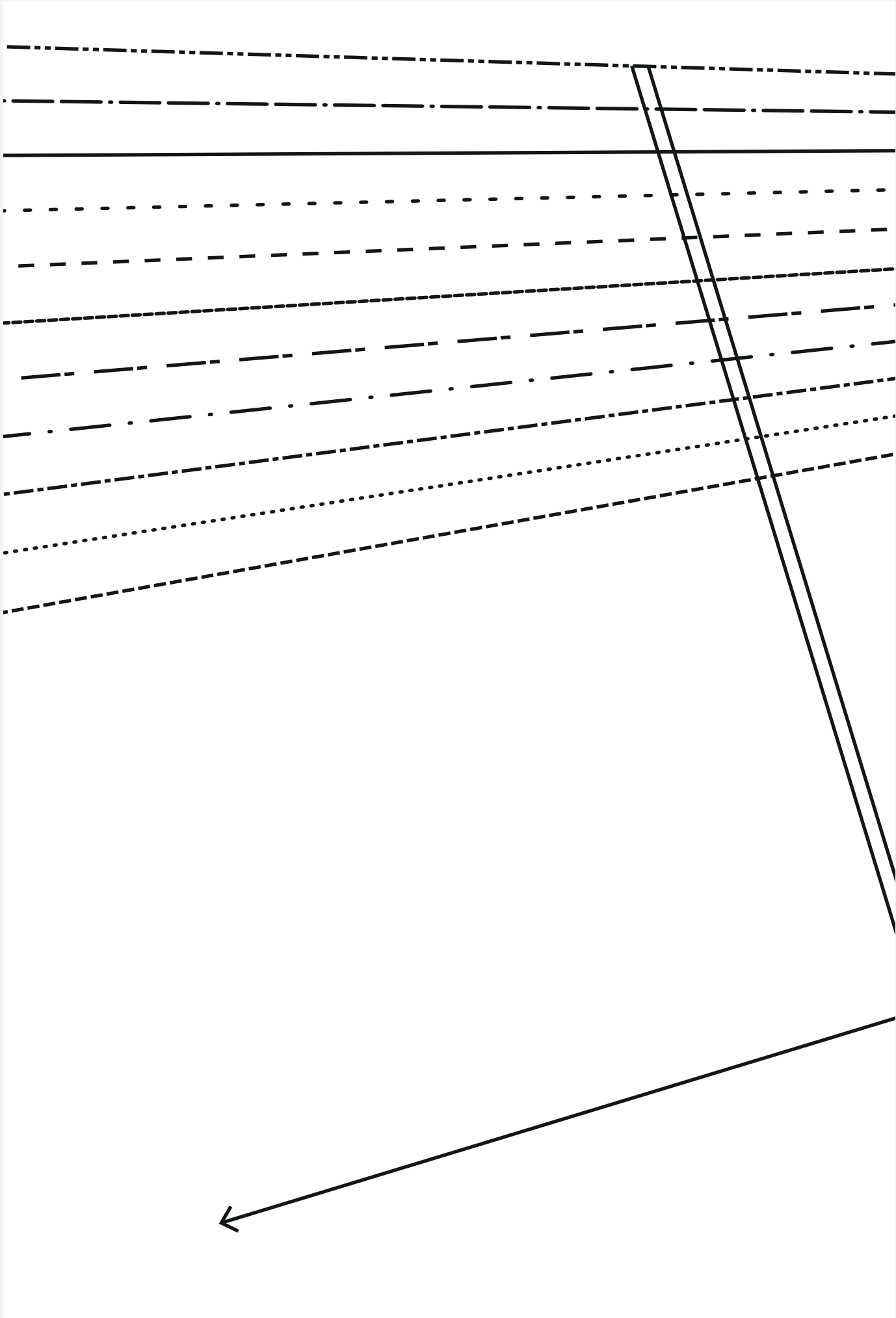

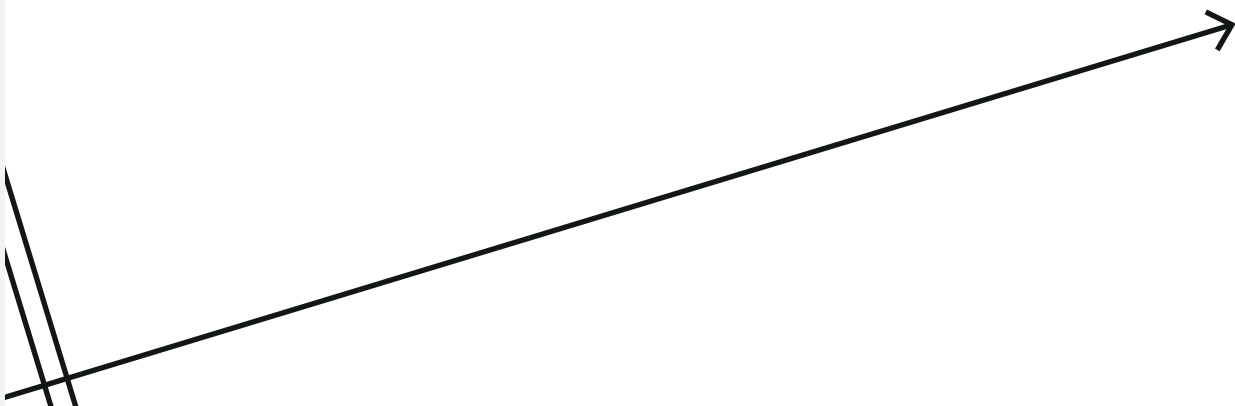
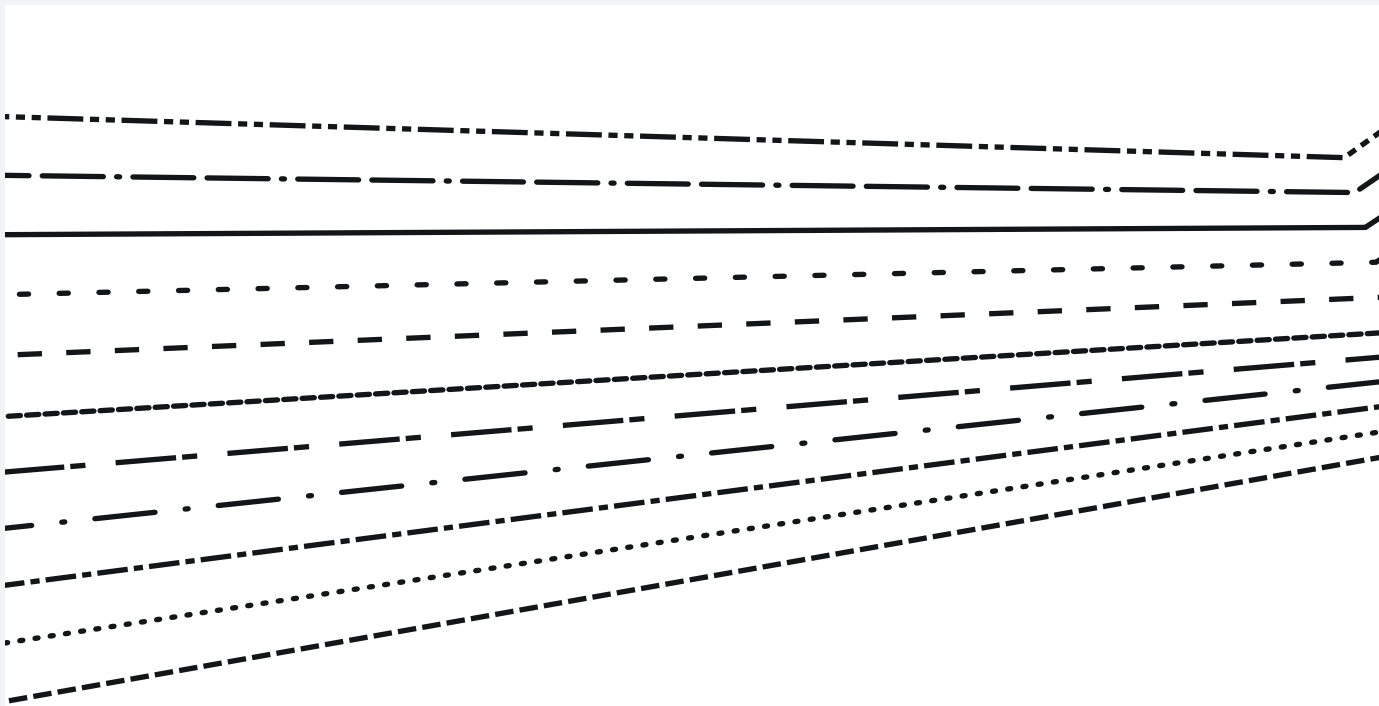

LIEN/SOHNTEHERE

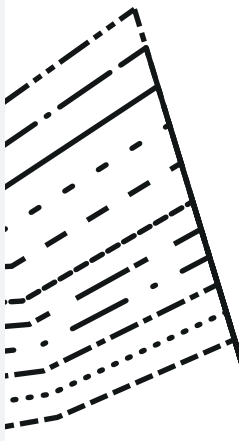

Cashmerette

G WWW.CASHMERETTE.COM

ne. Design by Cashmerette. Supplied by
tST. To be used for individual, private
manufacturing purposes. Not for resale.

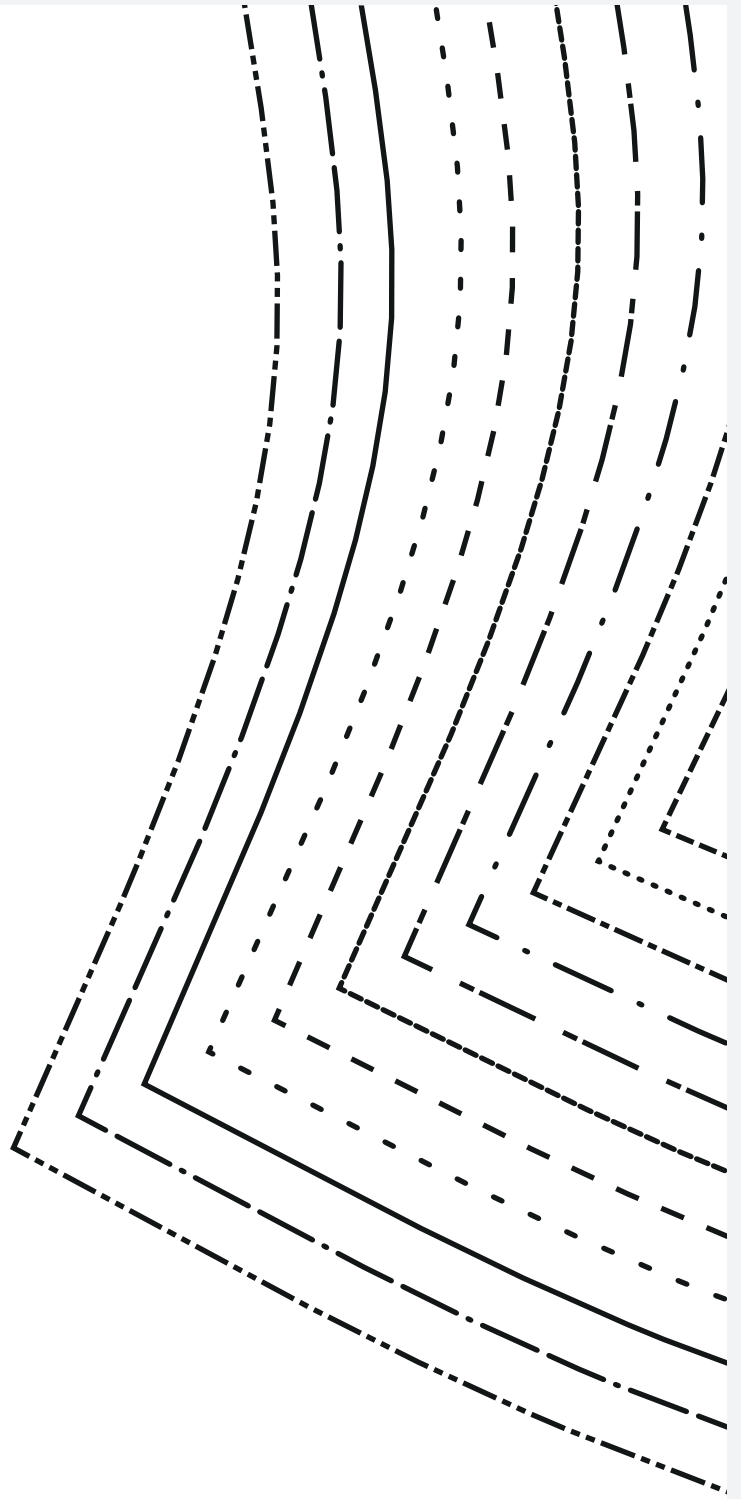

TM
Cashmere

2
STANNWAY T-SHIRT

Sleeve
Cut one pair

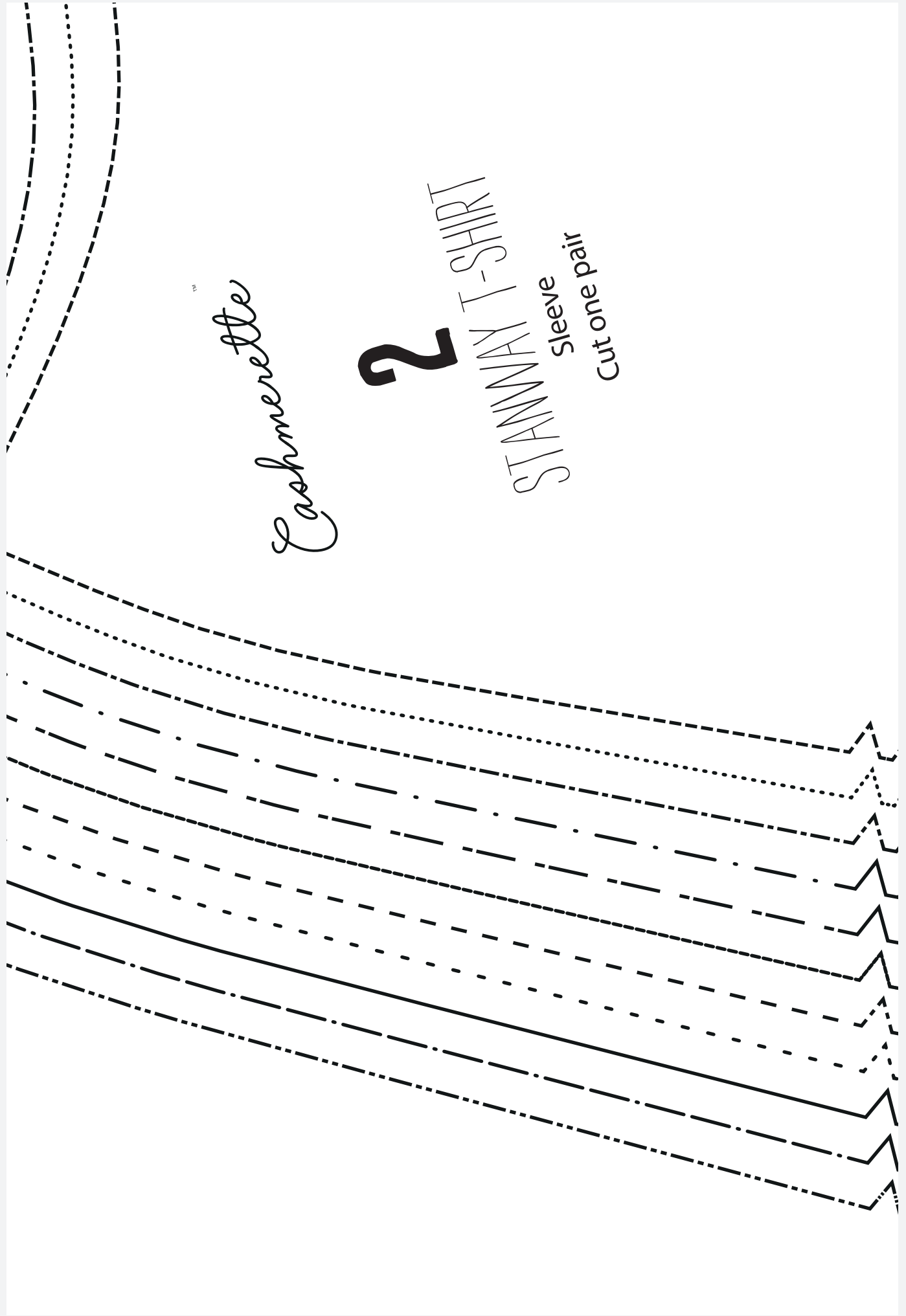

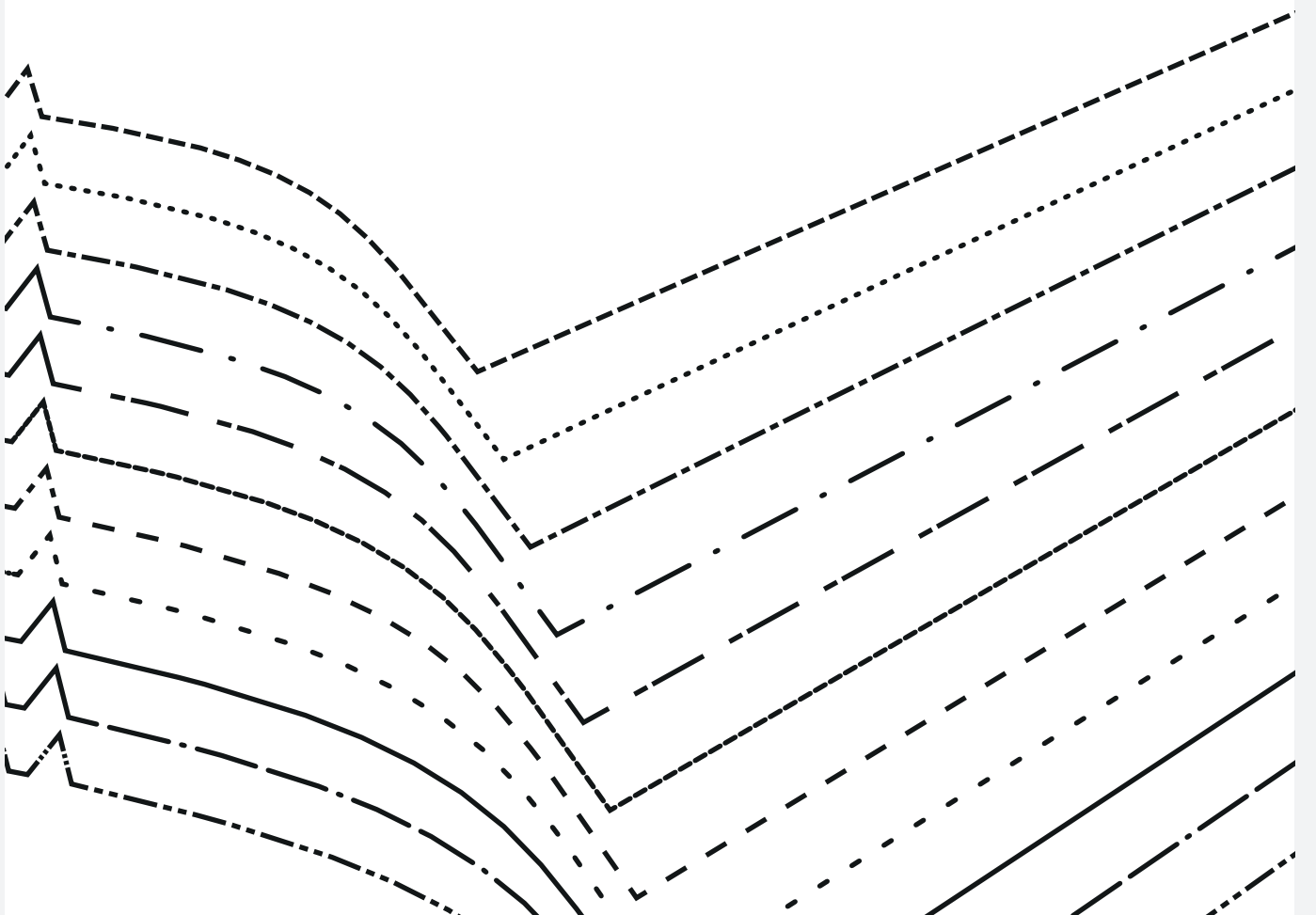

LENG

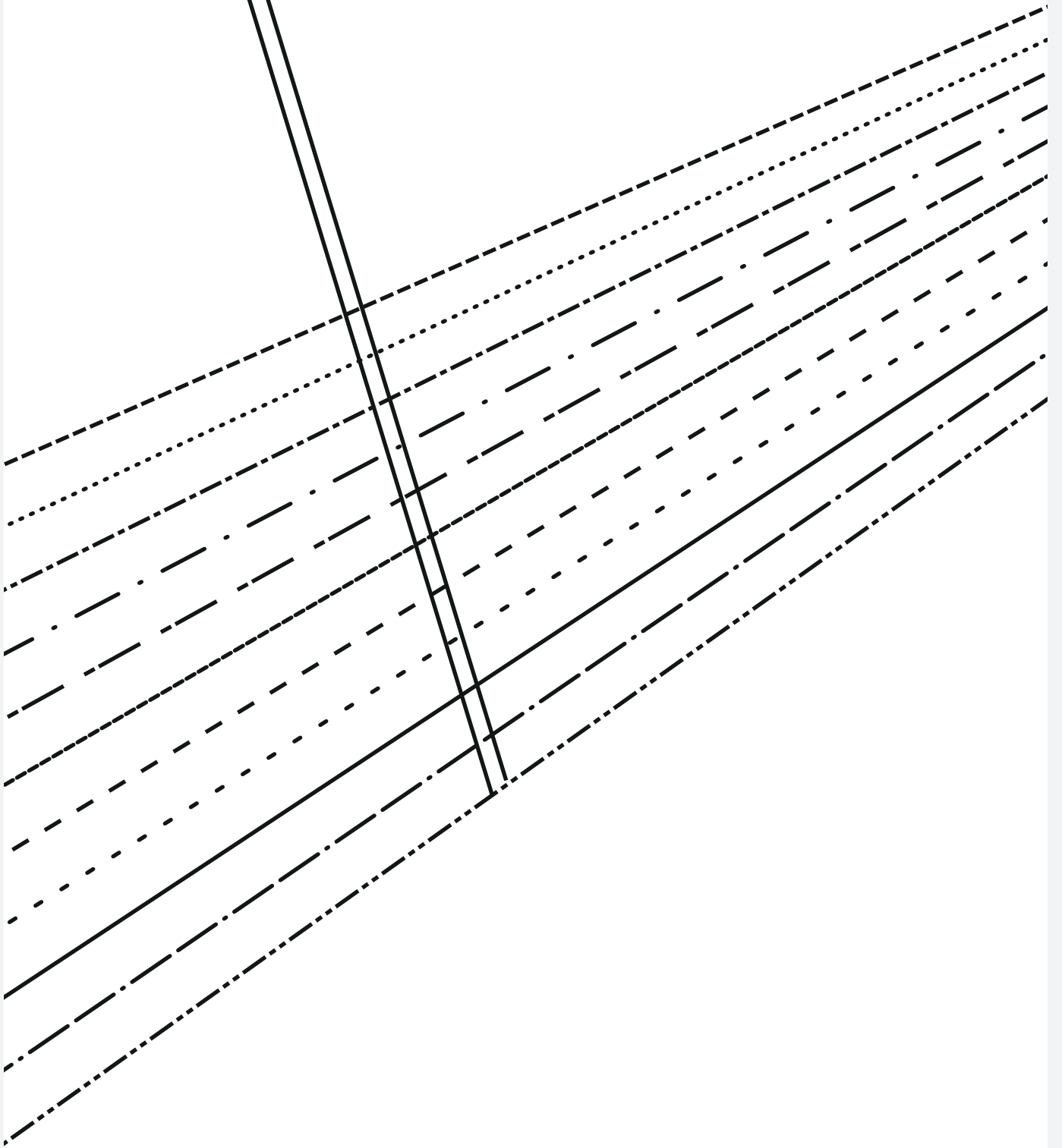

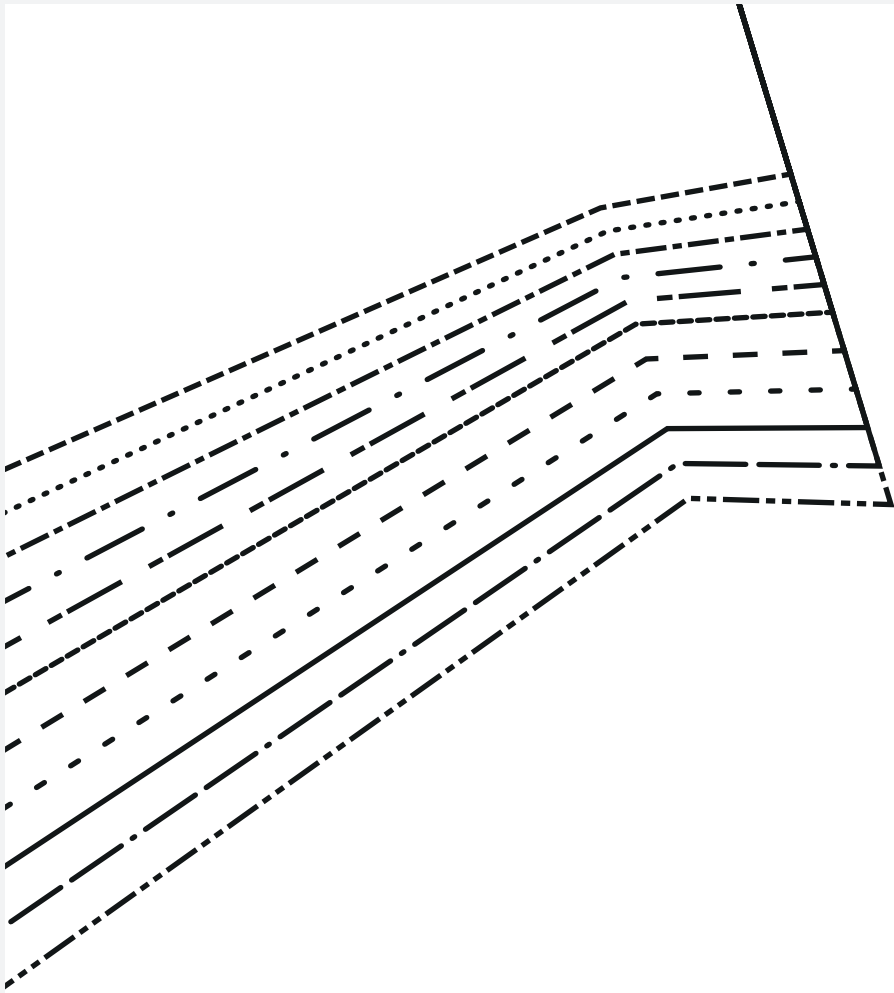



WWW.GATHERED.HOW/SIMPLYSEWIN

© Printed in the UK for Simply Sewing magazine
Immediate Media Company Ltd, Bristol, BS1 4
home use only and not for commercial or ma

SHEET 5 OF 5

